

# LM393B, LM2903B, LM193, LM293, LM393 and LM2903 Dual Comparators

## 1 Features

- NEW [LM393B](#) and [LM2903B](#)
- Improved specifications of B-version
  - Maximum rating: up to 38 V
  - ESD rating (HBM): 2k V
  - Low input offset: 0.37 mV
  - Low input bias current: 3.5 nA
  - Low supply-current: 200 µA per comparator
  - Faster response time of 1 µsec
  - Extended temperature range for LM393B
  - Available in tiny 2 x 2mm WSON package
- B-version is drop-in replacement for LM293, LM393 and LM2903, A and V versions
- Common-mode input voltage range includes ground
- Differential input voltage range equal to maximum-rated supply voltage: ±38 V
- Low output saturation voltage
- Output compatible with TTL, MOS, and CMOS

## 2 Applications

- [Vacuum robot](#)
- [Single phase UPS](#)
- [Server PSU](#)
- [Cordless power tool](#)
- [Wireless infrastructure](#)
- [Appliances](#)
- [Building automation](#)
- [Factory automation & control](#)
- [Motor drives](#)
- [Infotainment & cluster](#)

## 3 Description

The [LM393B](#) and [LM2903B](#) devices are the next generation versions of the industry-standard LM393 and LM2903 comparator family. These next generation B-version comparators feature lower offset voltage, higher supply voltage capability, lower supply current, lower input bias current, lower propagation delay, and improved 2 kV ESD performance and input ruggedness through dedicated ESD clamps. The LM393B and LM2903B can drop-in replace the LM293, LM393 and LM2903, for both "A" and "V" grades.

All devices consist of two independent voltage comparators that are designed to operate from a single power supply over a wide range of voltages. Quiescent current is independent of the supply voltage.

### Device Information

PART NUMBER	PACKAGE <sup>(1)</sup>	BODY SIZE (NOM)
LM393B, LM2903B, LM193, LM293, LM293A, LM393, LM393A, LM2903, LM2903V, LM2903AV	SOIC (8)	4.90 mm x 3.91 mm
LM393B, LM2903B, LM293, LM293A, LM393, LM393A, LM2903	VSSOP (8)	3.00 mm x 3.00 mm
LM293, LM393, LM393A, LM2903	PDIP (8)	9.81 mm × 6.35 mm
LM393, LM393A, LM2903	SO (8)	6.20 mm x 5.30 mm
LM393B, LM2903B, LM393, LM393A, LM2903, LM2903V, LM2903AV	TSSOP (8)	3.00 mm x 4.40 mm
LM393B, LM2903B	SOT-23 (8)	2.90 mm x 1.60 mm
LM393B, LM2903B	WSON (8)	2.00 mm × 2.00 mm

(1) For all available packages, see the orderable addendum at the end of the data sheet.

### Family Comparison Table

Specification	<a href="#">LM393B</a>	<a href="#">LM2903B</a>	<a href="#">LM393</a> <a href="#">LM393A</a>	<a href="#">LM2903</a>	<a href="#">LM2903V</a> <a href="#">LM2903AV</a>	<a href="#">LM193</a>	<a href="#">LM293</a> <a href="#">LM293A</a>	Units
Supply Voltage	2 to 36	2 to 36	2 to 30	2 to 30	2 to 32	2 to 30	2 to 30	V
Total Supply Current (5V to 36V max)	0.6 to 0.8	0.6 to 0.8	1 to 2.5	1 to 2.5	1 to 2.5	1 to 2.5	1 to 2.5	mA
Temperature Range	-40 to 85	-40 to 125	0 to 70	-40 to 125	-40 to 125	-55 to 125	-25 to 85	°C
ESD (HBM)	2000	2000	1000	1000	1000	1000	1000	V
Offset Voltage (Max over temp)	± 4	± 4	± 9 ± 4	± 15	± 15 ± 4	± 9	± 9 ± 4	mV
Input Bias Current (typ / max)	3.5 / 25	3.5 / 25	25 / 250	25 / 250	25 / 250	25 / 100	25 / 250	nA
Response Time (typ)	1	1	1.3	1.3	1.3	1.3	1.3	µsec



## Table of Contents

<b>1 Features</b> .....	1	6.14 Typical Characteristics, LMx93, LM2903 (all 'V' and 'A' suffixes).....	11
<b>2 Applications</b> .....	1	6.15 Typical Characteristics, LM393B and LM2903B.....	12
<b>3 Description</b> .....	1	<b>7 Detailed Description</b> .....	18
<b>4 Revision History</b> .....	2	7.1 Overview.....	18
<b>5 Pin Configuration and Functions</b> .....	3	7.2 Functional Block Diagram.....	18
<b>6 Specifications</b> .....	4	7.3 Feature Description.....	18
6.1 Absolute Maximum Ratings.....	4	7.4 Device Functional Modes.....	18
6.2 Recommended Operating Conditions.....	4	<b>8 Application and Implementation</b> .....	19
6.3 Thermal Information: LM193.....	5	8.1 Application Information.....	19
6.4 Thermal Information: LM293, LM393, LM2903 (all 'V' and 'A' suffixes).....	5	8.2 Typical Application.....	19
6.5 Thermal Information: LM393B and LM2903B.....	5	<b>9 Power Supply Recommendations</b> .....	21
6.6 ESD Ratings.....	5	<b>10 Layout</b> .....	21
6.7 Electrical Characteristics LM393B.....	6	10.1 Layout Guidelines.....	21
6.8 Electrical Characteristics LM2903B.....	7	10.2 Layout Example.....	21
6.9 Switching Characteristics LM393B and LM2903B.....	7	<b>11 Device and Documentation Support</b> .....	22
6.10 Electrical Characteristics for LM193, LM293, and LM393 (without A suffix).....	8	11.1 Receiving Notification of Documentation Updates..	22
6.11 Electrical Characteristics for LM293A and LM393A.....	9	11.2 Support Resources.....	22
6.12 Electrical Characteristics for LM2903, LM2903V, and LM2903AV.....	10	11.3 Trademarks.....	22
6.13 Switching Characteristics: LM193, LM293, LM393, LM2903, all 'A' and 'V' versions.....	10	11.4 Electrostatic Discharge Caution.....	22
		11.5 Glossary.....	22
		<b>12 Mechanical, Packaging, and Orderable Information</b> .....	22

## 4 Revision History

NOTE: Page numbers for previous revisions may differ from page numbers in the current version.

### Changes from Revision AC (February 2020) to Revision AD (October 2020) Page

- Updated the numbering format for tables, figures and cross-references throughout the document..... 1

### Changes from Revision AB (December 2019) to Revision AC (February 2020) Page

- Changed front page Features, Applications and Description text to highlight B version..... 1
- Added WSON and SOT-23-8 packages..... 1
- Added Links to Family Table..... 1
- Added DDF and DSG pkgs to Thermal Table..... 5

### Changes from Revision AA (September 2019) to Revision AB (December 2019) Page

- Changed LM393B and LM2903B from Preview to Active status..... 1
- Added Family Comparison Table..... 1

### Changes from Revision Z (October 2017) to Revision AA (September 2019) Page

- Added "B" devices with various text changes throughout datasheet..... 1
- Deleted from Device Information old LM193 CDIP and LCCC package references and drawings. These are on the LM139-MIL datasheet..... 1
- Added "B" devices Thermal Information table..... 5
- Added "B" device electrical tables..... 5
- Added "B" device graphs..... 12

## 5 Pin Configuration and Functions

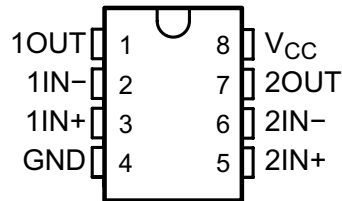

**Figure 5-1. D, DGK, JG, P, PS, DDF or PW Package 8-Pin SOIC, VSSOP, PDIP, SO, or TSSOP Top View**

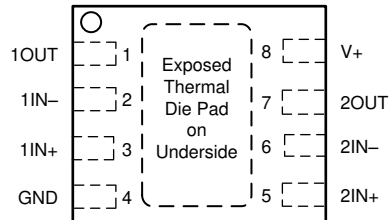

Connect thermal pad directly to GND pin.

**Figure 5-2. DSG Package 8-Pin WSON With Exposed Pad Top View**

**Table 5-1. Pin Functions**

NAME	PIN		I/O	DESCRIPTION
	SOIC, VSSOP, PDIP, SO, DDF and TSSOP	DSG		
1OUT	1	1	Output	Output pin of comparator 1
1IN-	2	2	Input	Negative input pin of comparator 1
1IN+	3	3	Input	Positive input pin of comparator 1
GND	4	4	—	Ground
2IN+	5	5	Input	Positive input pin of comparator 2
2IN-	6	6	Input	Negative input pin of comparator 2
2OUT	7	7	Output	Output pin of comparator 2
V <sub>CC</sub>	8	8	—	Positive Supply
Thermal Pad	—	PAD	—	Connect directly to GND pin

## 6 Specifications

### 6.1 Absolute Maximum Ratings

over operating free-air temperature range (unless otherwise noted) <sup>(1)</sup>

		MIN	MAX	UNIT
V <sub>CC</sub>	Supply voltage <sup>(2)</sup>	Non-B Versions	36	V
		B Versions Only	38	
V <sub>ID</sub>	Differential input voltage <sup>(3)</sup>	Non-B Versions	36	V
		B Versions Only	38	
V <sub>I</sub>	Input voltage (either input)	Non-B Versions	36	V
		B Versions Only	38	
I <sub>IK</sub>	Input current <sup>(5)</sup>		-50	mA
V <sub>O</sub>	Output voltage	Non-B Versions	36	V
		B Versions Only	38	
I <sub>O</sub>	Output current	Non-B Versions	20	mA
		B Versions Only	25	
I <sub>SC</sub>	Duration of output short circuit to ground <sup>(4)</sup>	Unlimited		
T <sub>J</sub>	Operating virtual-junction temperature		150	°C
T <sub>stg</sub>	Storage temperature	-65	150	°C

- (1) Stresses beyond those listed under *Absolute Maximum Ratings* may cause permanent damage to the device. These are stress ratings only, and functional operation of the device at these or any other conditions beyond those indicated under *Recommended Operating Conditions* is not implied. Exposure to absolute-maximum-rated conditions for extended periods may affect device reliability. Production Processing Does Not Necessarily Include Testing of All Parameters.
- (2) All voltage values, except differential voltages, are with respect to network ground.
- (3) Differential voltages are at IN+ with respect to IN-.
- (4) Short circuits from outputs to V<sub>CC</sub> can cause excessive heating and eventual destruction.
- (5) Input current flows thorough parasitic diode to ground and turns on parasitic transistors that increases I<sub>CC</sub> and may cause output to be incorrect. Normal operation resumes when input current is removed.

### 6.2 Recommended Operating Conditions

Over operating free-air temperature range (unless otherwise noted)

		MIN	MAX	UNIT
Supply voltage, V <sub>S</sub> = (V+) – (V-)	non-V devices	2	30	V
	V devices	2	32	
	"B" version devices	2	36	
Input voltage range, V <sub>IVR</sub>	non-B devices	0	(V+) – 2.0	V
	"B" version devices	-0.1		
Ambient temperature, T <sub>A</sub>	LM193	-55	125	°C
	LM2903, LM2903V, LM2903AV, LM2903B	-40	125	
	LM393B	-40	85	
	LM293, LM293A	-25	85	
	LM393, LM393A	0	70	

### 6.3 Thermal Information: LM193

THERMAL METRIC <sup>(1)</sup>		LM193	
		D (SOIC)	UNIT
		8 pin	
R <sub>θJA</sub>	Junction-to-ambient thermal resistance	126.4	°C/W
R <sub>θJC(top)</sub>	Junction-to-case (top) thermal resistance	70	°C/W
R <sub>θJB</sub>	Junction-to-board thermal resistance	64.9	°C/W
ψ <sub>JT</sub>	Junction-to-top characterization parameter	20.3	°C/W
ψ <sub>JB</sub>	Junction-to-board characterization parameter	64.5	°C/W
R <sub>θJC(bot)</sub>	Junction-to-case (bottom) thermal resistance	n/a	°C/W

(1) For more information about traditional and new thermal metrics, see the [Semiconductor and IC Package Thermal Metrics](#) report.

### 6.4 Thermal Information: LM293, LM393, LM2903 (all 'V' and 'A' suffixes)

THERMAL METRIC <sup>(1)</sup>		LM293, LM393, LM2903					UNIT
		D (SOIC)	DGK (VSSOP)	P (PDIP)	PS (SO)	PW (TSSOP)	
		8 pin	8 pin	8 pin	8 pin	8 pin	
R <sub>θJA</sub>	Junction-to-ambient thermal resistance	131.8	199.4	73.7	139	194.1	°C/W
R <sub>θJC(top)</sub>	Junction-to-case (top) thermal resistance	78.4	90.2	62.6	98.9	77.0	°C/W
R <sub>θJB</sub>	Junction-to-board thermal resistance	72.2	120.8	50.8	83.7	123.0	°C/W
ψ <sub>JT</sub>	Junction-to-top characterization parameter	26.5	21.5	39.2	47.4	13.1	°C/W
ψ <sub>JB</sub>	Junction-to-board characterization parameter	71.1	119.1	50.7	83	121.3	°C/W

(1) For more information about traditional and new thermal metrics, see the [Semiconductor and IC Package Thermal Metrics](#) report.

### 6.5 Thermal Information: LM393B and LM2903B

THERMAL METRIC <sup>(1)</sup>		LM393B, LM2903B					UNIT
		D (SOIC)	PW (TSSOP)	DGK (VSSOP)	DDF (SOT-23)	DSG (WSON)	
		8 pin	8 pin	8 pin	8 pin	8 pins	
R <sub>θJA</sub>	Junction-to-ambient thermal resistance	148.5	200.6	193.7	197.9	96.9	°C/W
R <sub>θJC(top)</sub>	Junction-to-case (top) thermal resistance	90.2	89.6	82.9	119.2	119.0	°C/W
R <sub>θJB</sub>	Junction-to-board thermal resistance	91.8	131.3	115.5	115.4	63.1	°C/W
ψ <sub>JT</sub>	Junction-to-top characterization parameter	38.5	22.1	20.8	19.4	12.4	°C/W
ψ <sub>JB</sub>	Junction-to-board characterization parameter	91.1	129.6	113.9	113.7	63.0	°C/W
R <sub>θJC(bot)</sub>	Junction-to-case (bottom) thermal resistance	-	-	-	-	37.8	°C/W

(1) For more information about traditional and new thermal metrics, see the [Semiconductor and IC Package Thermal Metrics](#) report.

### 6.6 ESD Ratings

			VALUE	UNIT
<b>LM393B and LM2903B Only</b>				
V <sub>(ESD)</sub>	Electrostatic discharge	Human body model (HBM), per ANSI/ESDA/JEDEC JS-001 <sup>(1)</sup>	±2000	V
		Charged-device model (CDM), per JEDEC specification JESD22-C101 <sup>(2)</sup>	±1000	
<b>All Other Versions</b>				
V <sub>(ESD)</sub>	Electrostatic discharge	Human body model (HBM), per ANSI/ESDA/JEDEC JS-001 <sup>(1)</sup>	±1000	V
		Charged-device model (CDM), per JEDEC specification JESD22-C101 <sup>(2)</sup>	±750	

(1) JEDEC document JEP155 states that 500-V HBM allows safe manufacturing with a standard ESD control process.

(2) JEDEC document JEP157 states that 250-V CDM allows safe manufacturing with a standard ESD control process.

## 6.7 Electrical Characteristics LM393B

$V_S = 5\text{ V}$ ,  $V_{CM} = (V_-)$ ;  $T_A = 25^\circ\text{C}$  (unless otherwise noted).

PARAMETER		TEST CONDITIONS	MIN	TYP	MAX	UNIT
$V_{IO}$	Input offset voltage	$V_S = 5\text{ to }36\text{V}$	-2.5	$\pm 0.37$	2.5	mV
		$V_S = 5\text{ to }36\text{V}$ , $T_A = -40^\circ\text{C to }+85^\circ\text{C}$	-4		4	
	Input offset voltage, DGK package only	$V_S = 5\text{ to }36\text{V}$	-3.5	$\pm 0.37$	3.5	
		$V_S = 5\text{ to }36\text{V}$ , $T_A = -40^\circ\text{C to }+85^\circ\text{C}$	-5		5	
$I_B$	Input bias current			-3.5	-25	nA
		$T_A = -40^\circ\text{C to }+85^\circ\text{C}$			-50	nA
$I_{OS}$	Input offset current		-10	$\pm 0.5$	10	nA
		$T_A = -40^\circ\text{C to }+85^\circ\text{C}$	-25		25	nA
$V_{CM}$	Common mode range (1)	$V_S = 3\text{ to }36\text{V}$	(V-)		(V+) - 1.5	V
		$V_S = 3\text{ to }36\text{V}$ , $T_A = -40^\circ\text{C to }+85^\circ\text{C}$	(V-)		(V+) - 2.0	V
$A_{VD}$	Large signal differential voltage amplification	$V_S = 15\text{V}$ , $V_O = 1.4\text{V to }11.4\text{V}$ ; $R_L \geq 15\text{k to }(V_+)$	50	200		V/mV
$V_{OL}$	Low level output Voltage {swing from (V-)}	$I_{SINK} \leq 4\text{mA}$ , $V_{ID} = -1\text{V}$		110	400	mV
		$I_{SINK} \leq 4\text{mA}$ , $V_{ID} = -1\text{V}$ $T_A = -40^\circ\text{C to }+85^\circ\text{C}$			550	mV
$I_{OH-LKG}$	High-level output leakage current	$(V_+) = V_O = 5\text{V}$ ; $V_{ID} = 1\text{V}$		0.1	20	nA
		$(V_+) = V_O = 36\text{V}$ ; $V_{ID} = 1\text{V}$		0.3	50	nA
$I_{OL}$	Low level output current	$V_{OL} = 1.5\text{V}$ ; $V_{ID} = -1\text{V}$ ; $V_S = 5\text{V}$	6	21		mA
$I_Q$	Quiescent current (all comparators)	$V_S = 5\text{V}$ , no load		400	600	$\mu\text{A}$
		$V_S = 36\text{V}$ , no load, $T_A = -40^\circ\text{C to }+85^\circ\text{C}$		550	800	$\mu\text{A}$

- (1) The voltage at either input should not be allowed to go negative by more than 0.3 V otherwise output may be incorrect and excessive input current can flow. The upper end of the common-mode voltage range is limited by  $V_{CC} - 2\text{V}$ . However only one input needs to be in the valid common mode range, the other input can go up the maximum  $V_{CC}$  level and the comparator provides a proper output state. Either or both inputs can go to maximum  $V_{CC}$  level without damage.

## 6.8 Electrical Characteristics LM2903B

$V_S = 5\text{ V}$ ,  $V_{CM} = (V-)$ ;  $T_A = 25^\circ\text{C}$  (unless otherwise noted).

PARAMETER		TEST CONDITIONS	MIN	TYP	MAX	UNIT
$V_{IO}$	Input offset voltage	$V_S = 5\text{ to }36\text{V}$	-2.5	$\pm 0.37$	2.5	mV
		$V_S = 5\text{ to }36\text{V}$ , $T_A = -40^\circ\text{C to }+125^\circ\text{C}$	-4		4	
	Input offset voltage, DGK package only	$V_S = 5\text{ to }36\text{V}$	-3.5	$\pm 0.37$	3.5	
		$V_S = 5\text{ to }36\text{V}$ , $T_A = -40^\circ\text{C to }+125^\circ\text{C}$	-5		5	
$I_B$	Input bias current			-3.5	-25	nA
		$T_A = -40^\circ\text{C to }+125^\circ\text{C}$				-50
$I_{OS}$	Input offset current		-10	$\pm 0.5$	10	nA
		$T_A = -40^\circ\text{C to }+125^\circ\text{C}$				-25
$V_{CM}$	Common mode range (1)	$V_S = 3\text{ to }36\text{V}$	(V-)		(V+) - 1.5	V
		$V_S = 3\text{ to }36\text{V}$ , $T_A = -40^\circ\text{C to }+125^\circ\text{C}$	(V-)		(V+) - 2.0	V
$A_{VD}$	Large signal differential voltage amplification	$V_S = 15\text{V}$ , $V_O = 1.4\text{V to }11.4\text{V}$ ; $R_L \geq 15\text{k to }(V+)$	50	200		V/mV
$V_{OL}$	Low level output Voltage {swing from (V-)}	$I_{SINK} \leq 4\text{mA}$ , $V_{ID} = -1\text{V}$		110	400	mV
		$I_{SINK} \leq 4\text{mA}$ , $V_{ID} = -1\text{V}$ $T_A = -40^\circ\text{C to }+125^\circ\text{C}$			550	mV
$I_{OH-LKG}$	High-level output leakage current	(V+) = $V_O = 5\text{ V}$ ; $V_{ID} = 1\text{V}$		0.1	20	nA
		(V+) = $V_O = 36\text{V}$ ; $V_{ID} = 1\text{V}$		0.3	50	nA
$I_{OL}$	Low level output current	$V_{OL} = 1.5\text{V}$ ; $V_{ID} = -1\text{V}$ ; $V_S = 5\text{V}$	6	21		mA
$I_Q$	Quiescent current (all comparators)	$V_S = 5\text{ V}$ , no load		400	600	$\mu\text{A}$
		$V_S = 36\text{ V}$ , no load, $T_A = -40^\circ\text{C to }+125^\circ\text{C}$		550	800	$\mu\text{A}$

- (1) The voltage at either input should not be allowed to go negative by more than 0.3 V otherwise output may be incorrect and excessive input current can flow. The upper end of the common-mode voltage range is limited by  $V_{CC} - 2\text{V}$ . However only one input needs to be in the valid common mode range, the other input can go up the maximum  $V_{CC}$  level and the comparator provides a proper output state. Either or both inputs can go to maximum  $V_{CC}$  level without damage.

## 6.9 Switching Characteristics LM393B and LM2903B

$V_S = 5\text{V}$ ,  $V_{O\_PULLUP} = 5\text{V}$ ,  $V_{CM} = V_S/2$ ,  $C_L = 15\text{pF}$ ,  $R_L = 5.1\text{k Ohm}$ ,  $T_A = 25^\circ\text{C}$  (unless otherwise noted).

PARAMETER		TEST CONDITIONS	MIN	TYP	MAX	UNIT
$t_{\text{response}}$	Propagation delay time, high-to-low; TTL input signal (1)	TTL input with $V_{\text{ref}} = 1.4\text{V}$		300		ns
$t_{\text{response}}$	Propagation delay time, high-to-low; Small scale input signal (1)	Input overdrive = 5mV, Input step = 100mV		1000		ns

- (1) High-to-low and low-to-high refers to the transition at the input.

## 6.10 Electrical Characteristics for LM193, LM293, and LM393 (without A suffix)

at specified free-air temperature,  $V_{CC} = 5\text{ V}$  (unless otherwise noted)

PARAMETER	TEST CONDITIONS	$T_A$ <sup>(1)</sup>	LM193			LM293 LM393			UNIT	
			MIN	TYP	MAX	MIN	TYP	MAX		
$V_{IO}$ Input offset voltage	$V_{CC} = 5\text{ V to }30\text{ V}$ , $V_{IC} = V_{ICR}\text{ min}$ , $V_O = 1.4\text{ V}$	25°C		2	5		2	5	mV	
		Full range			9			9		
$I_{IO}$ Input offset current	$V_O = 1.4\text{ V}$	25°C		3	25		5	50	nA	
		Full range			100			250		
$I_{IB}$ Input bias current	$V_O = 1.4\text{ V}$	25°C		-25	-100		-25	-250	nA	
		Full range			-300			-400		
$V_{ICR}$ Common-mode input-voltage range <sup>(2)</sup>		25°C		0 to $V_{CC} - 1.5$			0 to $V_{CC} - 1.5$		V	
		Full range		0 to $V_{CC} - 2$			0 to $V_{CC} - 2$			
$A_{VD}$ Large-signal differential-voltage amplification	$V_{CC} = 15\text{ V}$ , $V_O = 1.4\text{ V to }11.4\text{ V}$ , $R_L \geq 15\text{ k}\Omega\text{ to }V_{CC}$	25°C		50	200		50	200	V/mV	
$I_{OH}$ High-level output current	$V_{OH} = 5\text{ V}$	$V_{ID} = 1\text{ V}$	25°C		0.1		0.1	50	nA	
	$V_{OH} = 30\text{ V}$	$V_{ID} = 1\text{ V}$	Full range			1		1	$\mu\text{A}$	
$V_{OL}$ Low-level output voltage	$I_{OL} = 4\text{ mA}$ , $V_{ID} = -1\text{ V}$	25°C		150	400		130	400	mV	
		Full range			700			700		
$I_{OL}$ Low-level output current	$V_{OL} = 1.5\text{ V}$ , $V_{ID} = -1\text{ V}$	25°C		6			6		mA	
$I_{CC}$ Supply current	$R_L = \infty$	$V_{CC} = 5\text{ V}$	25°C		0.8	1		0.45	1	mA
		$V_{CC} = 30\text{ V}$	Full range			2.5		0.55	2.5	

- (1) Full range (minimum or maximum) for LM193 is  $-55^\circ\text{C}$  to  $125^\circ\text{C}$ , for LM293 is  $-25^\circ\text{C}$  to  $85^\circ\text{C}$ , and for LM393 is  $0^\circ\text{C}$  to  $70^\circ\text{C}$ . All characteristics are measured with zero common-mode input voltage, unless otherwise specified.
- (2) The voltage at either input should not be allowed to go negative by more than 0.3 V otherwise output may be incorrect and excessive input current can flow. The upper end of the common-mode voltage range is limited by  $V_{CC} - 2\text{ V}$ . However only one input needs to be in the valid common mode range, the other input can go up the maximum  $V_{CC}$  level and the comparator provides a proper output state. Either or both inputs can go to maximum  $V_{CC}$  level without damage.



## 6.11 Electrical Characteristics for LM293A and LM393A

at specified free-air temperature,  $V_{CC} = 5\text{ V}$  (unless otherwise noted)

PARAMETER	TEST CONDITIONS	$T_A$ <sup>(1)</sup>	LM293A LM393A			UNIT
			MIN	TYP	MAX	
$V_{IO}$ Input offset voltage	$V_{CC} = 5\text{ V to }30\text{ V}, V_O = 1.4\text{ V}$ $V_{IC} = V_{ICR(min)}$	25°C		1	2	mV
		Full range			4	
$I_{IO}$ Input offset current	$V_O = 1.4\text{ V}$	25°C		5	50	nA
		Full range			150	
$I_{IB}$ Input bias current	$V_O = 1.4\text{ V}$	25°C		-25	-250	nA
		Full range			-400	
$V_{ICR}$ Common-mode input-voltage range <sup>(2)</sup>		25°C		0 to $V_{CC} - 1.5$		V
		Full range		0 to $V_{CC} - 2$		
$A_{VD}$ Large-signal differential-voltage amplification	$V_{CC} = 15\text{ V}, V_O = 1.4\text{ V to }11.4\text{ V},$ $R_L \geq 15\text{ k}\Omega \text{ to } V_{CC}$	25°C		50	200	V/mV
$I_{OH}$ High-level output current	$V_{OH} = 5\text{ V},$ $V_{ID} = 1\text{ V}$	25°C		0.1	50	nA
	$V_{OH} = 30\text{ V},$ $V_{ID} = 1\text{ V}$	Full range			1	$\mu\text{A}$
$V_{OL}$ Low-level output voltage	$I_{OL} = 4\text{ mA},$ $V_{ID} = -1\text{ V}$	25°C		110	400	mV
		Full range			700	
$I_{OL}$ Low-level output current	$V_{OL} = 1.5\text{ V},$ $V_{ID} = -1\text{ V},$	25°C		6		mA
$I_{CC}$ Supply current	$R_L = \infty$	$V_{CC} = 5\text{ V}$	25°C	0.60	1	mA
		$V_{CC} = 30\text{ V}$	Full range	0.72	2.5	

- (1) Full range (minimum or maximum) for LM293A is  $-25^\circ\text{C}$  to  $85^\circ\text{C}$ , and for LM393A is  $0^\circ\text{C}$  to  $70^\circ\text{C}$ . All characteristics are measured with zero common-mode input voltage, unless otherwise specified.
- (2) The voltage at either input should not be allowed to go negative by more than 0.3 V otherwise output may be incorrect and excessive input current can flow. The upper end of the common-mode voltage range is limited by  $V_{CC} - 2\text{V}$ . However only one input needs to be in the valid common mode range, the other input can go up the maximum  $V_{CC}$  level and the comparator provides a proper output state. Either or both inputs can go to maximum  $V_{CC}$  level without damage.

## 6.12 Electrical Characteristics for LM2903, LM2903V, and LM2903AV

at specified free-air temperature,  $V_{CC} = 5\text{ V}$  (unless otherwise noted)

PARAMETER	TEST CONDITIONS	$T_A$ <sup>(1)</sup>	LM2903, LM2903V			LM2903AV			UNIT	
			MIN	TYP	MAX	MIN	TYP	MAX		
$V_{IO}$ Input offset voltage	$V_{CC} = 5\text{ V to MAX}^{(2)}$ , $V_O = 1.4\text{ V}$ , $V_{IC} = V_{ICR(min)}$	25°C		2	7		1	2	mV	
		Full range			15			4		
$I_{IO}$ Input offset current	$V_O = 1.4\text{ V}$	25°C		5	50		5	50	nA	
		Full range			200			200		
$I_{IB}$ Input bias current	$V_O = 1.4\text{ V}$	25°C		-25	-250		-25	-250	nA	
		Full range			-500			-500		
$V_{ICR}$ Common-mode input-voltage range <sup>(3)</sup>		25°C		0 to $V_{CC} - 1.5$			0 to $V_{CC} - 1.5$		V	
		Full range		0 to $V_{CC} - 2$			0 to $V_{CC} - 2$			
$A_{VD}$ Large-signal differential-voltage amplification	$V_{CC} = 15\text{ V}$ , $V_O = 1.4\text{ V to } 11.4\text{ V}$ , $R_L \geq 15\text{ k}\Omega\text{ to } V_{CC}$	25°C		25	100		25	100	V/mV	
$I_{OH}$ High-level output current	$V_{OH} = 5\text{ V}$ , $V_{ID} = 1\text{ V}$	25°C			0.1	50		0.1	50	nA
	$V_{OH} = V_{CC}\text{ MAX}^{(2)}$ , $V_{ID} = 1\text{ V}$	Full range				1			1	$\mu\text{A}$
$V_{OL}$ Low-level output voltage	$I_{OL} = 4\text{ mA}$ , $V_{ID} = -1\text{ V}$	25°C			150	400		150	400	mV
		Full range				700			700	
$I_{OL}$ Low-level output current	$V_{OL} = 1.5\text{ V}$ , $V_{ID} = -1\text{ V}$	25°C		6			6		mA	
$I_{CC}$ Supply current	$R_L = \infty$	$V_{CC} = 5\text{ V}$	25°C		0.8	1		0.8	1	mA
		$V_{CC} = \text{MAX}$	Full range			2.5			2.5	

- (1) Full range (minimum or maximum) for LM2903 is  $-40^\circ\text{C}$  to  $125^\circ\text{C}$ . All characteristics are measured with zero common-mode input voltage, unless otherwise specified.
- (2)  $V_{CC}\text{ MAX} = 30\text{ V}$  for non-V devices and  $32\text{ V}$  for V-suffix devices.
- (3) The voltage at either input should not be allowed to go negative by more than  $0.3\text{ V}$  otherwise output may be incorrect and excessive input current can flow. The upper end of the common-mode voltage range is limited by  $V_{CC} - 2\text{ V}$ . However only one input needs to be in the valid common mode range, the other input can go up the maximum  $V_{CC}$  level and the comparator provides a proper output state. Either or both inputs can go to maximum  $V_{CC}$  level without damage.

## 6.13 Switching Characteristics: LM193, LM239, LM393, LM2903, all 'A' and 'V' versions

$V_{CC} = 5\text{ V}$ ,  $T_A = 25^\circ\text{C}$

PARAMETER	TEST CONDITIONS	TYP	UNIT
Response time	$R_L$ connected to $5\text{ V}$ through $5.1\text{ k}\Omega$ , $C_L = 15\text{ pF}^{(1)(2)}$	100-mV input step with 5-mV overdrive	1.3
		TTL-level input step	0.3

- (1)  $C_L$  includes probe and jig capacitance.
- (2) The response time specified is the interval between the input step function and the instant when the output crosses  $1.4\text{ V}$ .

### 6.14 Typical Characteristics, LMx93, LM2903 (all 'V' and 'A' suffixes)

$T_A = 25^\circ\text{C}$ ,  $V_S = 5\text{V}$ ,  $R_{\text{PULLUP}} = 5.1\text{k}$ ,  $C_L = 15\text{pF}$ ,  $V_{\text{CM}} = 0\text{V}$  unless otherwise noted.

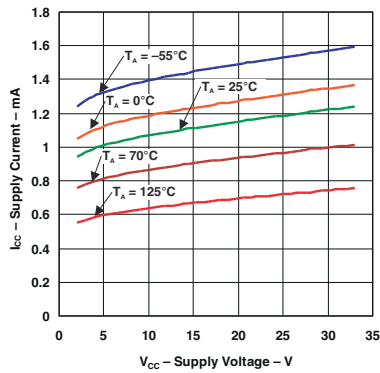

Figure 6-1. Supply Current vs Supply Voltage

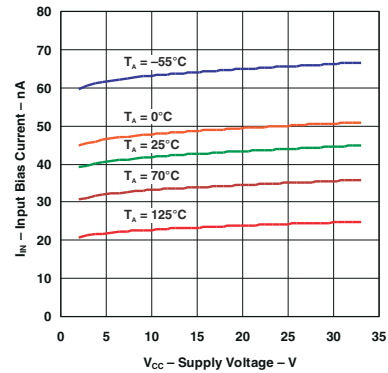

Figure 6-2. Input Bias Current vs Supply Voltage

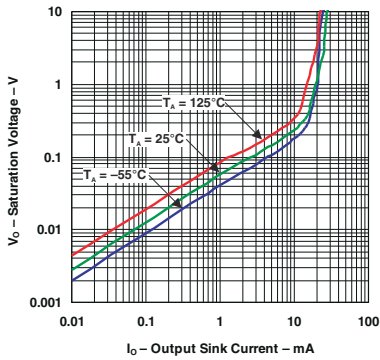

Figure 6-3. Output Saturation Voltage

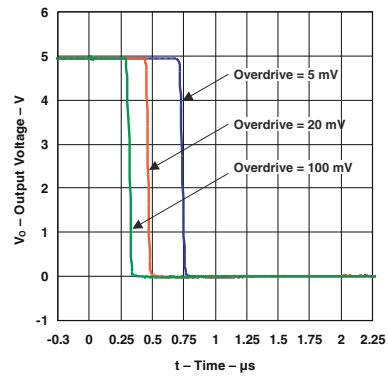

Figure 6-4. Response Time for Various Overdrives Negative Transition

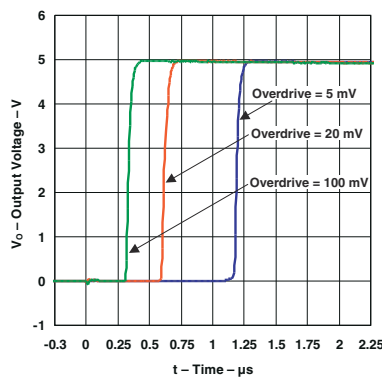

Figure 6-5. Response Time for Various Overdrives Positive Transition

### 6.15 Typical Characteristics, LM393B and LM2903B

$T_A = 25^\circ\text{C}$ ,  $V_S = 5\text{ V}$ ,  $R_{\text{PULLUP}} = 5.1\text{k}$ ,  $C_L = 15\text{ pF}$ ,  $V_{\text{CM}} = 0\text{ V}$ ,  $V_{\text{UNDERDRIVE}} = 100\text{ mV}$ ,  $V_{\text{OVERDRIVE}} = 100\text{ mV}$  unless otherwise noted.

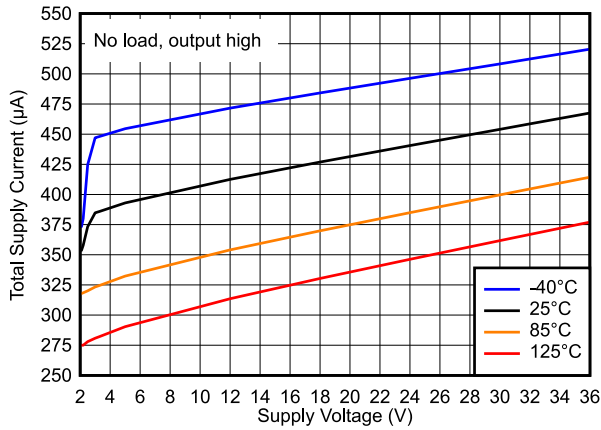

Figure 6-6. Total Supply Current vs. Supply Voltage

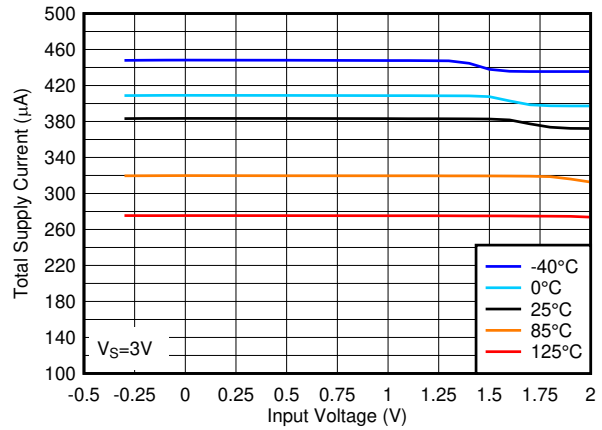

Figure 6-7. Total Supply Current vs. Input Voltage at 3V

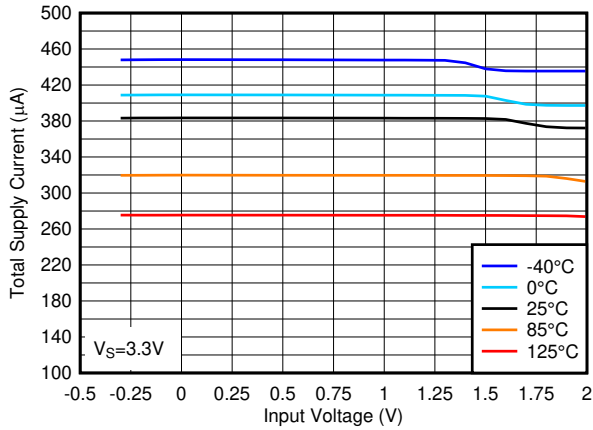

Figure 6-8. Total Supply Current vs. Input Voltage at 3.3V

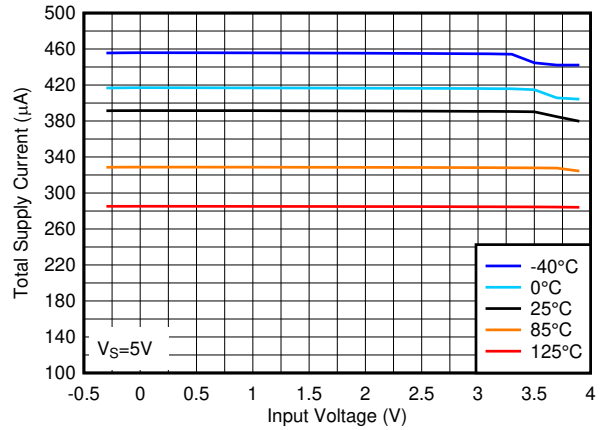

Figure 6-9. Total Supply Current vs. Input Voltage at 5V

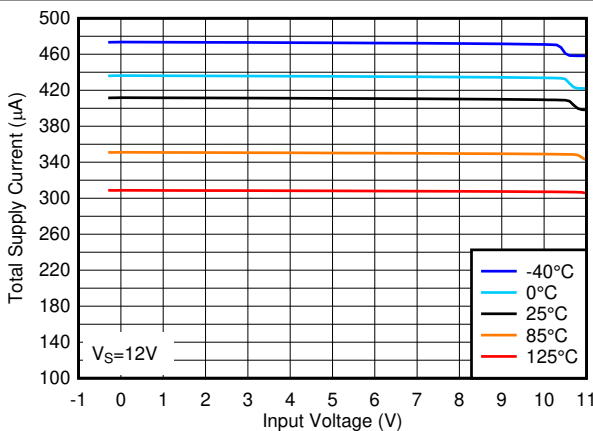

Figure 6-10. Total Supply Current vs. Input Voltage at 12V

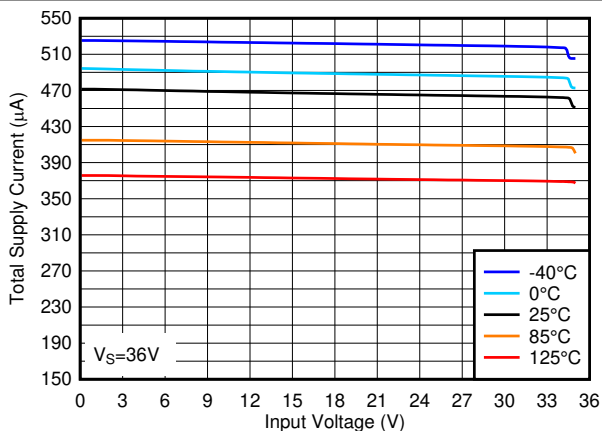

Figure 6-11. Total Supply Current vs. Input Voltage at 36V

### 6.15 Typical Characteristics, LM393B and LM2903B (continued)

$T_A = 25^\circ\text{C}$ ,  $V_S = 5\text{ V}$ ,  $R_{\text{PULLUP}} = 5.1\text{ k}$ ,  $C_L = 15\text{ pF}$ ,  $V_{\text{CM}} = 0\text{ V}$ ,  $V_{\text{UNDERDRIVE}} = 100\text{ mV}$ ,  $V_{\text{OVERDRIVE}} = 100\text{ mV}$  unless otherwise noted.

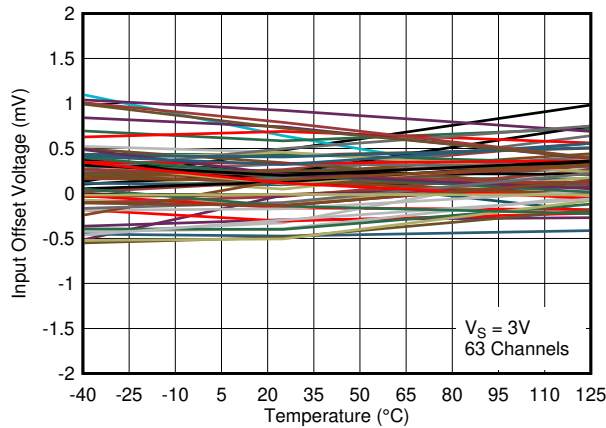

Figure 6-12. Input Offset Voltage vs. Temperature at 3V

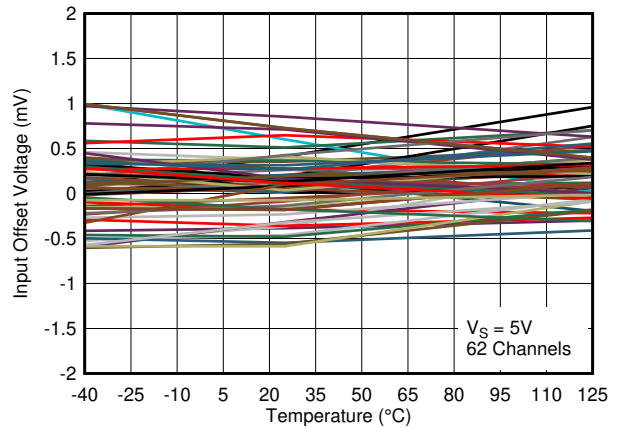

Figure 6-13. Input Offset Voltage vs. Temperature at 5V

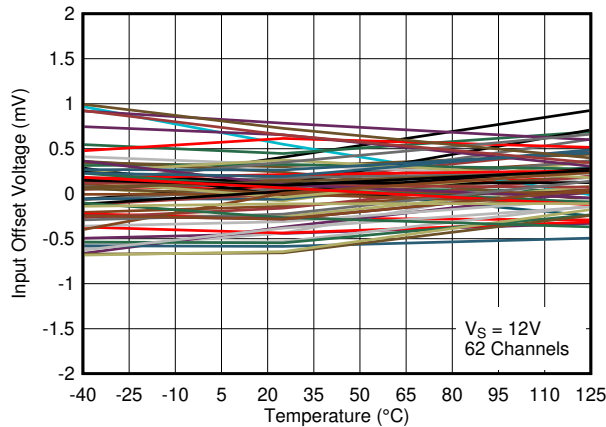

Figure 6-14. Input Offset Voltage vs. Temperature at 12V

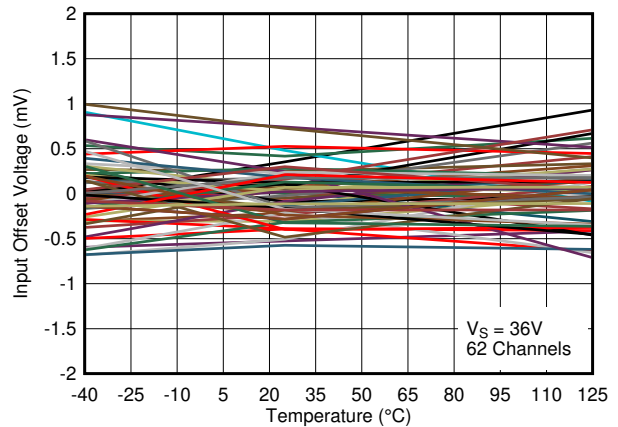

Figure 6-15. Input Offset Voltage vs. Temperature at 36V

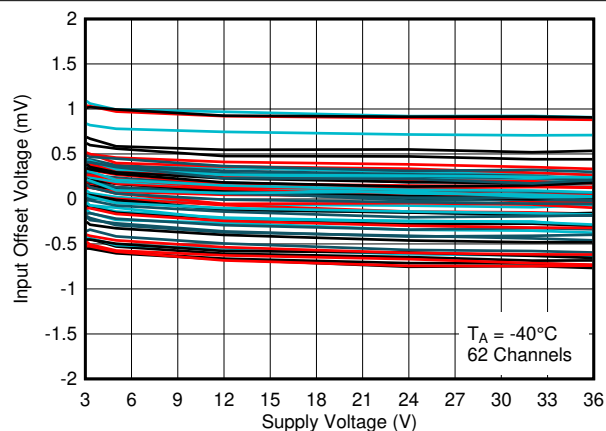

Figure 6-16. Input Offset Voltage vs. Supply Voltage at  $-40^\circ\text{C}$

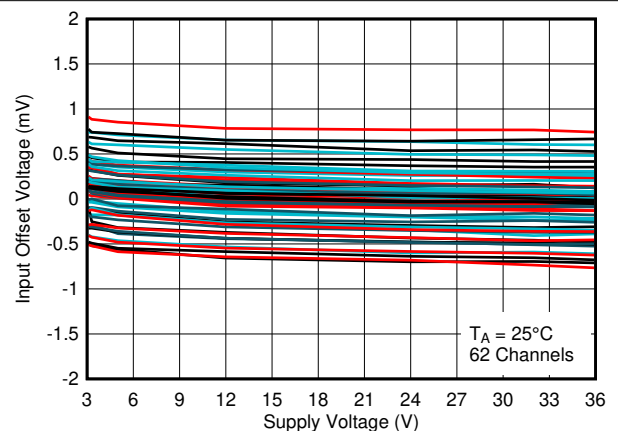

Figure 6-17. Input Offset Voltage vs. Supply Voltage at  $25^\circ\text{C}$

### 6.15 Typical Characteristics, LM393B and LM2903B (continued)

$T_A = 25^\circ\text{C}$ ,  $V_S = 5\text{ V}$ ,  $R_{\text{PULLUP}} = 5.1\text{ k}$ ,  $C_L = 15\text{ pF}$ ,  $V_{\text{CM}} = 0\text{ V}$ ,  $V_{\text{UNDERDRIVE}} = 100\text{ mV}$ ,  $V_{\text{OVERDRIVE}} = 100\text{ mV}$  unless otherwise noted.

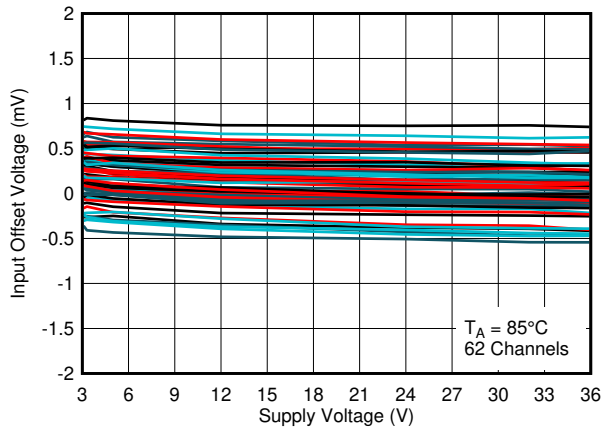

Figure 6-18. Input Offset Voltage vs. Supply Voltage at 85°C

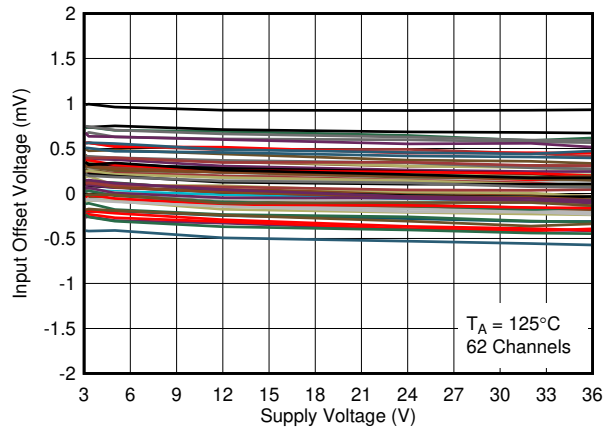

Figure 6-19. Input Offset Voltage vs. Supply Voltage at 125°C

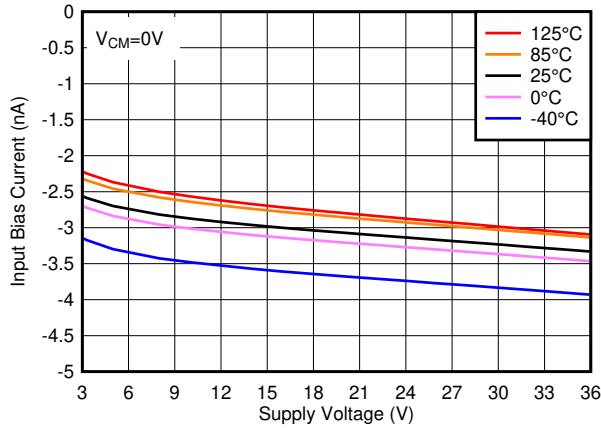

Figure 6-20. Input Bias Current vs. Supply Voltage

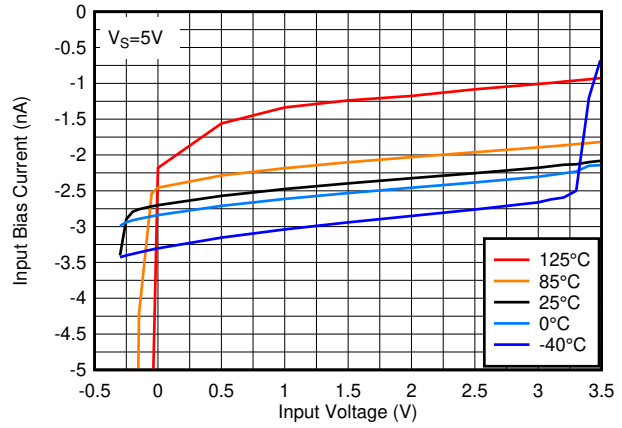

Figure 6-21. Input Bias Current vs. Input Voltage at 5V

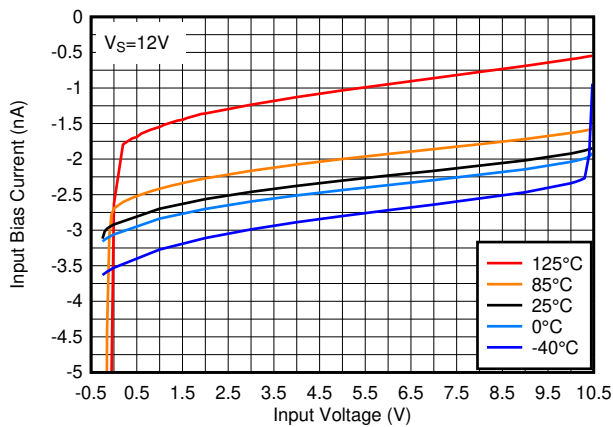

Figure 6-22. Input Bias Current vs. Input Voltage at 12V

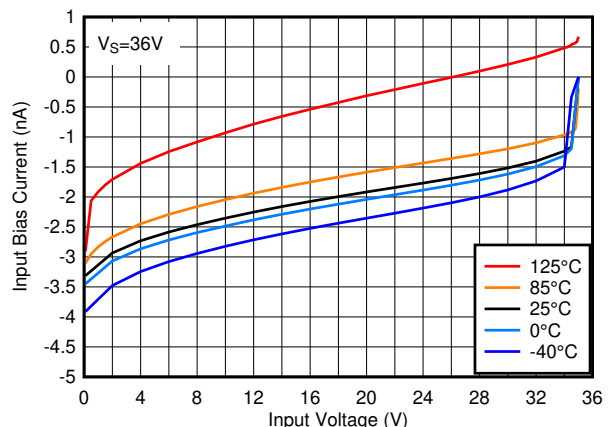
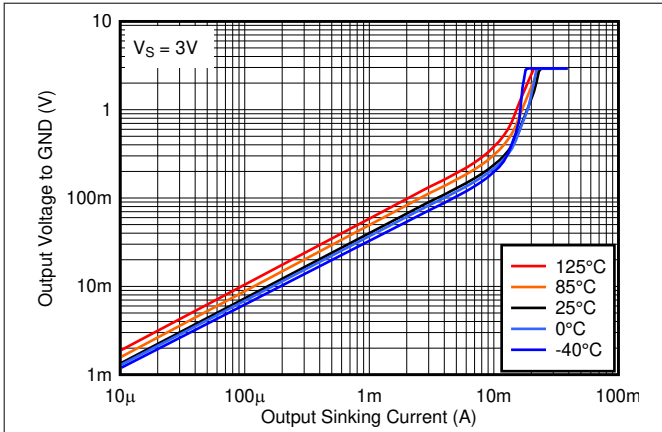

Figure 6-23. Input Bias Current vs. Input Voltage at 36V

### 6.15 Typical Characteristics, LM393B and LM2903B (continued)

$T_A = 25^\circ\text{C}$ ,  $V_S = 5\text{ V}$ ,  $R_{\text{PULLUP}} = 5.1\text{k}$ ,  $C_L = 15\text{ pF}$ ,  $V_{\text{CM}} = 0\text{ V}$ ,  $V_{\text{UNDERDRIVE}} = 100\text{ mV}$ ,  $V_{\text{OVERDRIVE}} = 100\text{ mV}$  unless otherwise noted.



**Figure 6-24. Output Low Voltage vs. Output Sinking Current at 3V**

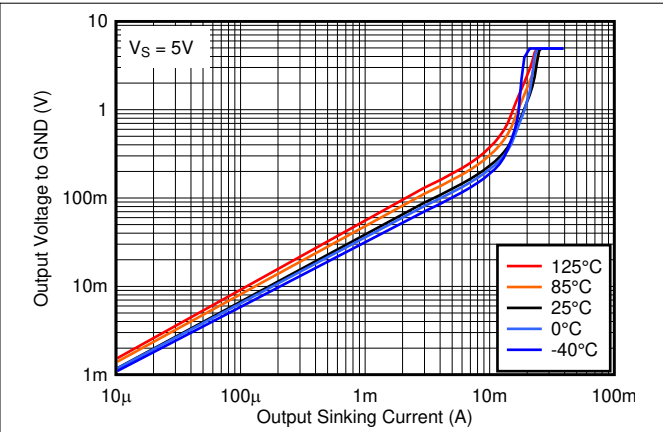

**Figure 6-25. Output Low Voltage vs. Output Sinking Current at 5V**

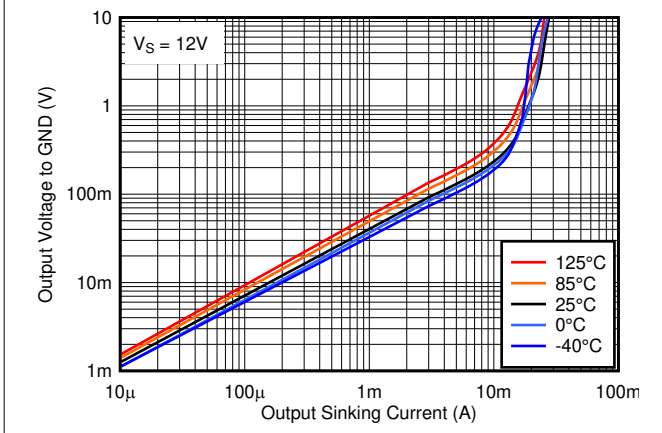

**Figure 6-26. Output Low Voltage vs. Output Sinking Current at 12V**

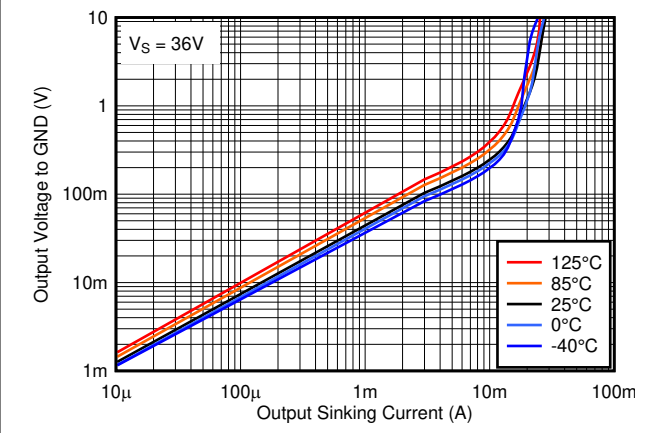

**Figure 6-27. Output Low Voltage vs. Output Sinking Current at 36V**

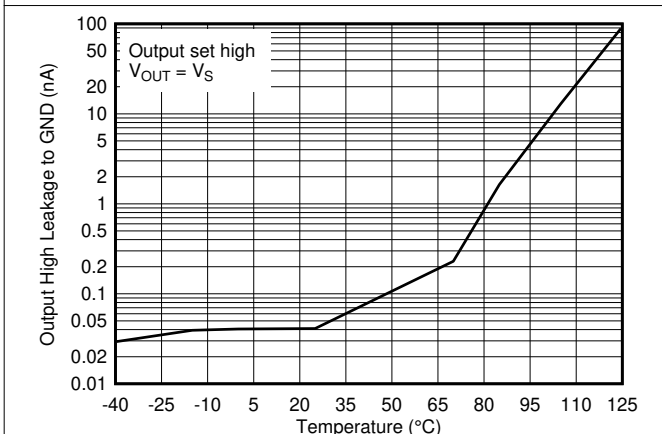

**Figure 6-28. Output High Leakage Current vs. Temperature at 5V**

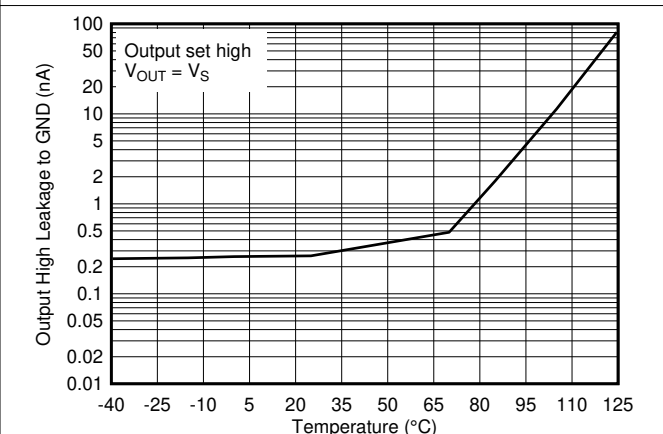

**Figure 6-29. Output High Leakage Current vs. Temperature at 36V**

### 6.15 Typical Characteristics, LM393B and LM2903B (continued)

$T_A = 25^\circ\text{C}$ ,  $V_S = 5\text{ V}$ ,  $R_{\text{PULLUP}} = 5.1\text{ k}$ ,  $C_L = 15\text{ pF}$ ,  $V_{\text{CM}} = 0\text{ V}$ ,  $V_{\text{UNDERDRIVE}} = 100\text{ mV}$ ,  $V_{\text{OVERDRIVE}} = 100\text{ mV}$  unless otherwise noted.

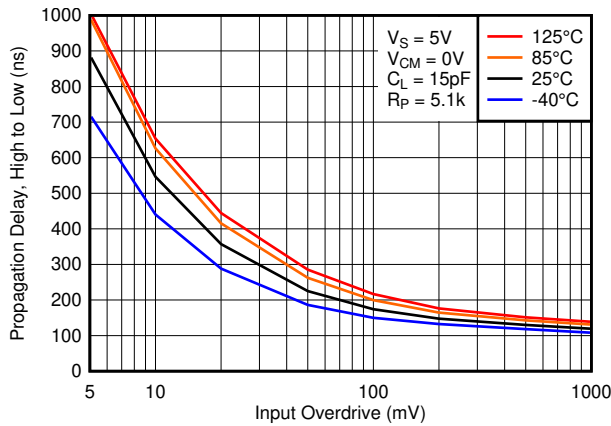

**Figure 6-30. High to Low Propagation Delay vs. Input Overdrive Voltage, 5V**

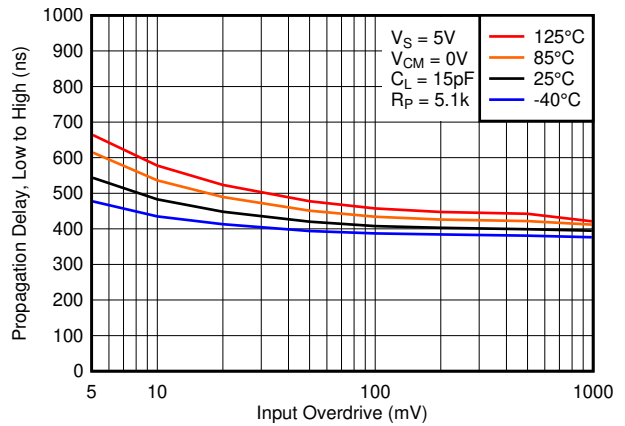

**Figure 6-31. Low to High Propagation Delay vs. Input Overdrive Voltage, 5V**

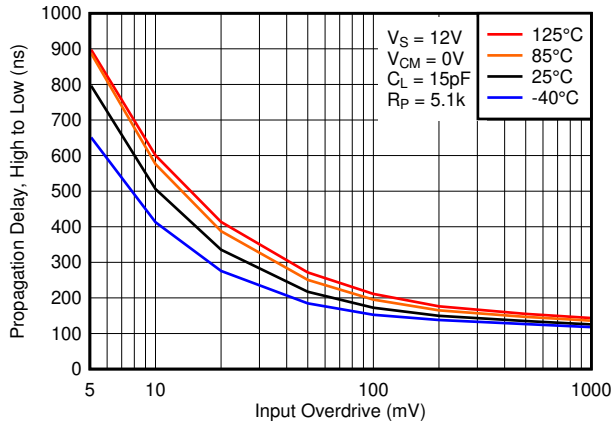

**Figure 6-32. High to Low Propagation Delay vs. Input Overdrive Voltage, 12V**

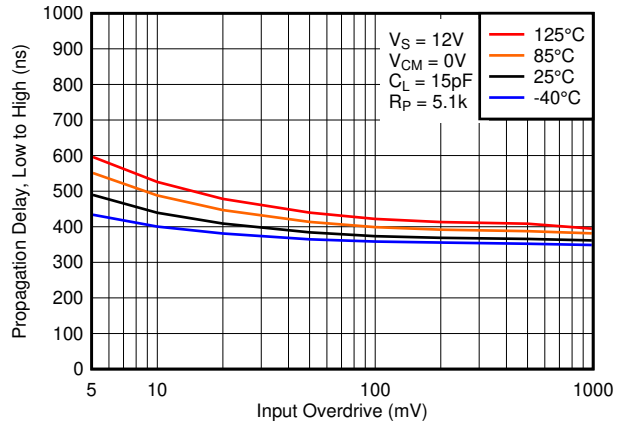

**Figure 6-33. Low to High Propagation Delay vs. Input Overdrive Voltage, 12V**

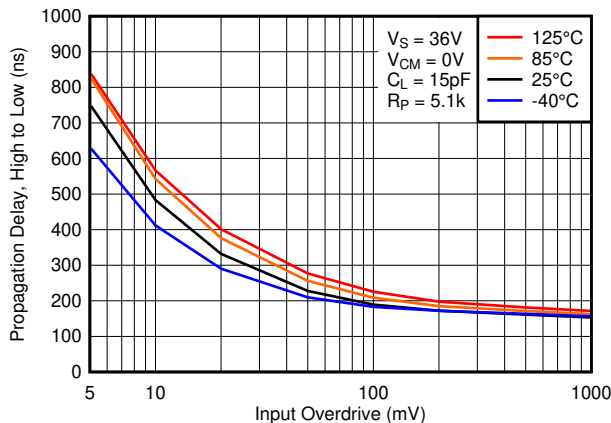

**Figure 6-34. High to Low Propagation Delay vs. Input Overdrive Voltage, 36V**

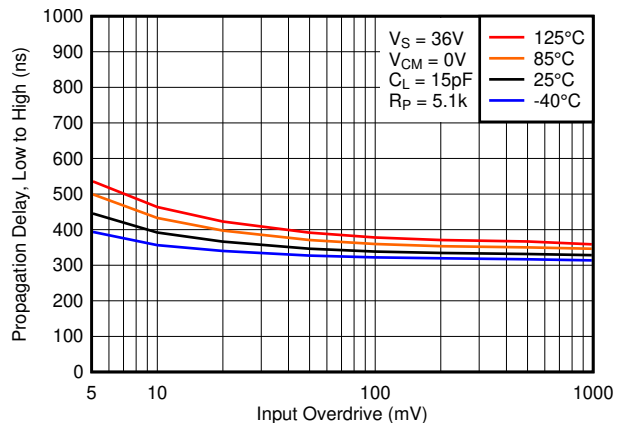
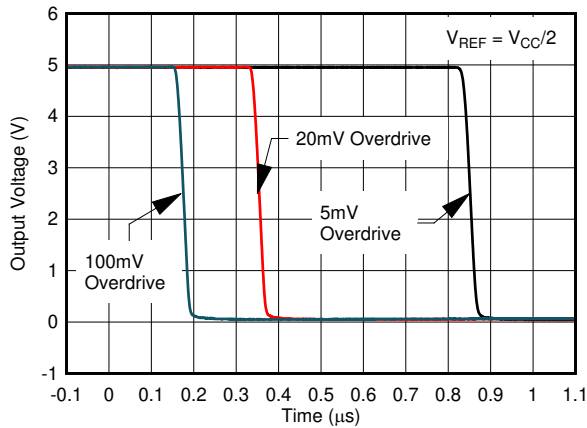

**Figure 6-35. Low to High Propagation Delay vs. Input Overdrive Voltage, 36V**



### 6.15 Typical Characteristics, LM393B and LM2903B (continued)

$T_A = 25^\circ\text{C}$ ,  $V_S = 5\text{ V}$ ,  $R_{\text{PULLUP}} = 5.1\text{ k}\Omega$ ,  $C_L = 15\text{ pF}$ ,  $V_{\text{CM}} = 0\text{ V}$ ,  $V_{\text{UNDERDRIVE}} = 100\text{ mV}$ ,  $V_{\text{OVERDRIVE}} = 100\text{ mV}$  unless otherwise noted.



**Figure 6-36. Response Time for Various Overdrives, High-to-Low Transition**

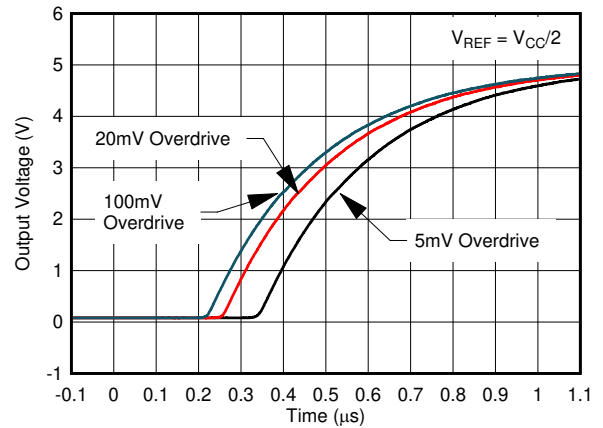

**Figure 6-37. Response Time for Various Overdrives, Low-to-High Transition**

## 7 Detailed Description

### 7.1 Overview

These dual comparators have the ability to operate up to absolute maximum of 36 V (38 V for the "B" version) on the supply pin. This device has proven ubiquity and versatility across a wide range of applications. This is due to very wide supply voltages range, low Iq and fast response of the devices.

The open-drain output allows the user to configure the output's logic high voltage ( $V_{OH}$ ) and can be used to enable the comparator to be used in AND functionality.

### 7.2 Functional Block Diagram

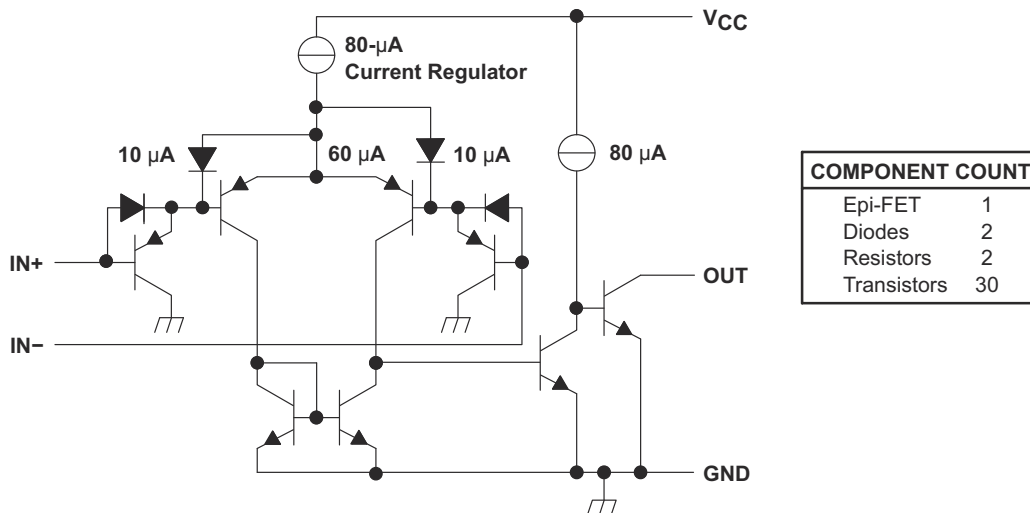

Figure 7-1. Schematic (Each Comparator)

### 7.3 Feature Description

The comparator consists of a PNP darlington pair input, allowing the device to operate with very high gain and fast response with minimal input bias current. The input Darlington pair creates a limit on the input common mode voltage capability, allowing the comparator to accurately function from ground to  $V_{CC} - 1.5$  V input. Allow for  $V_{CC} - 2$  V at cold temperature.

The output consists of an open drain NPN (pull-down or low side) transistor. The output NPN sinks current when the negative input voltage is higher than the positive input voltage and the offset voltage. The  $V_{OL}$  is resistive and scales with the output current. See Figure 6-3 for  $V_{OL}$  values with respect to the output current.

### 7.4 Device Functional Modes

#### 7.4.1 Voltage Comparison

The device operates solely as a voltage comparator, comparing the differential voltage between the positive and negative pins and outputting a logic low or high impedance (logic high with pullup) based on the input differential polarity.

## 8 Application and Implementation

### Note

Information in the following applications sections is not part of the TI component specification, and TI does not warrant its accuracy or completeness. TI's customers are responsible for determining suitability of components for their purposes. Customers should validate and test their design implementation to confirm system functionality.

### 8.1 Application Information

The device is typically used to compare a single signal to a reference or two signals against each other. Many users take advantage of the open drain output to drive the comparison logic output to a logic voltage level to an MCU or logic device. The wide supply range and high voltage capability makes this comparator optimal for level shifting to a higher or lower voltage.

### 8.2 Typical Application

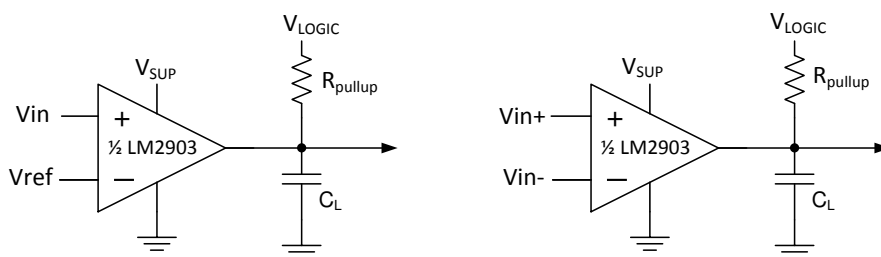

Figure 8-1. Single-Ended and Differential Comparator Configurations

#### 8.2.1 Design Requirements

For this design example, use the parameters listed in Table 8-1 as the input parameters.

Table 8-1. Design Parameters

DESIGN PARAMETER	EXAMPLE VALUE
Input Voltage Range	0 V to $V_{sup}-2$ V
Supply Voltage	4.5 V to $V_{CC}$ maximum
Logic Supply Voltage	0 V to $V_{CC}$ maximum
Output Current ( $R_{PULLUP}$ )	1 $\mu$ A to 4 mA
Input Overdrive Voltage	100 mV
Reference Voltage	2.5 V
Load Capacitance ( $C_L$ )	15 pF

#### 8.2.2 Detailed Design Procedure

When using the device in a general comparator application, determine the following:

- Input Voltage Range
- Minimum Overdrive Voltage
- Output and Drive Current
- Response Time

##### 8.2.2.1 Input Voltage Range

When choosing the input voltage range, the input common mode voltage range ( $V_{ICR}$ ) must be taken in to account. If temperature operation is below 25°C the  $V_{ICR}$  can range from 0 V to  $V_{CC}-2.0$  V. This limits the input voltage range to as high as  $V_{CC}-2.0$  V and as low as 0 V. Operation outside of this range can yield incorrect comparisons.

The following is a list of input voltage situation and their outcomes:

1. When both IN- and IN+ are both within the common-mode range:
  - a. If IN- is higher than IN+ and the offset voltage, the output is low and the output transistor is sinking current
  - b. If IN- is lower than IN+ and the offset voltage, the output is high impedance and the output transistor is not conducting
2. When IN- is higher than common-mode and IN+ is within common-mode, the output is low and the output transistor is sinking current
3. When IN+ is higher than common-mode and IN- is within common-mode, the output is high impedance and the output transistor is not conducting
4. When IN- and IN+ are both higher than common-mode, the output is low and the output transistor is sinking current

### 8.2.2.2 Minimum Overdrive Voltage

Overdrive Voltage is the differential voltage produced between the positive and negative inputs of the comparator over the offset voltage ( $V_{IO}$ ). To make an accurate comparison the Overdrive Voltage ( $V_{OD}$ ) should be higher than the input offset voltage ( $V_{IO}$ ). Overdrive voltage can also determine the response time of the comparator, with the response time decreasing with increasing overdrive. Figure 8-2 and Figure 8-3 show positive and negative response times with respect to overdrive voltage.

### 8.2.2.3 Output and Drive Current

Output current is determined by the load/pull-up resistance and logic/pullup voltage. The output current produces a output low voltage ( $V_{OL}$ ) from the comparator. In which  $V_{OL}$  is proportional to the output current. Use Section 6.14 to determine  $V_{OL}$  based on the output current.

The output current can also effect the transient response. See Section 8.2.2.4 for more information.

### 8.2.2.4 Response Time

Response time is a function of input over drive. See Section 8.2.3 for typical response times. The rise and falls times can be determined by the load capacitance ( $C_L$ ), load/pullup resistance ( $R_{PULLUP}$ ) and equivalent collector-emitter resistance ( $R_{CE}$ ).

- The rise time ( $T_R$ ) is approximately  $T_R \sim R_{PULLUP} \times C_L$
- The fall time ( $T_F$ ) is approximately  $T_F \sim R_{CE} \times C_L$ 
  - $R_{CE}$  can be determine by taking the slope of Section 6.14 in its linear region at the desired temperature, or by dividing the  $V_{OL}$  by  $I_{out}$

## 8.2.3 Application Curves

The following curves were generated with 5 V on  $V_{CC}$  and  $V_{Logic}$ ,  $R_{PULLUP} = 5.1 \text{ k}\Omega$ , and 50 pF scope probe.

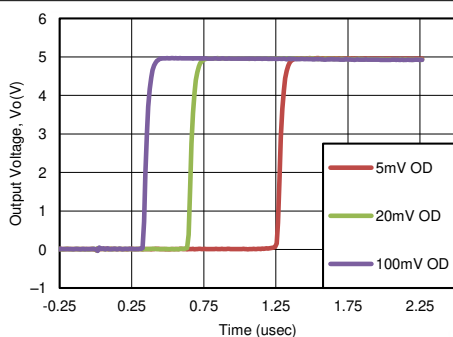

**Figure 8-2. Response Time for Various Overdrives (Positive Transition)**

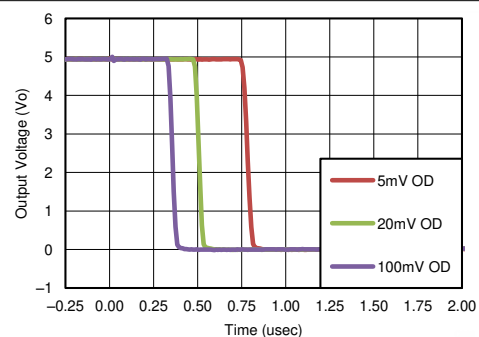

**Figure 8-3. Response Time for Various Overdrives (Negative Transition)**

## 9 Power Supply Recommendations

For fast response and comparison applications with noisy or AC inputs, TI recommends to use a bypass capacitor on the supply pin to reject any variation on the supply voltage. This variation can eat into the input common-mode range of the comparator and create an inaccurate comparison.

## 10 Layout

### 10.1 Layout Guidelines

For accurate comparator applications without hysteresis it is important maintain a stable power supply with minimized noise and glitches. To achieve this, it is best to add a bypass capacitor between the supply voltage and ground. This should be implemented on the positive power supply and negative supply (if available). If a negative supply is not being used, do not put a capacitor between the IC's GND pin and system ground.

Minimize coupling between outputs and inverting inputs to prevent output oscillations. Do not run output and inverting input traces in parallel unless there is a  $V_{CC}$  or GND trace between output and inverting input traces to reduce coupling. When series resistance is added to inputs, place resistor close to the device.

### 10.2 Layout Example

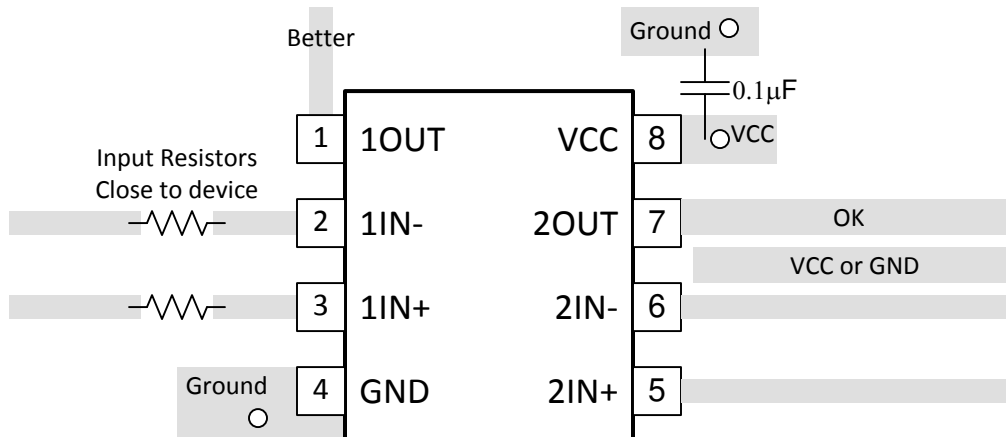

**Figure 10-1. LM2903 Layout Example**

## 11 Device and Documentation Support

### 11.1 Receiving Notification of Documentation Updates

To receive notification of documentation updates, navigate to the device product folder on [ti.com](http://ti.com). Click on *Subscribe to updates* to register and receive a weekly digest of any product information that has changed. For change details, review the revision history included in any revised document.

### 11.2 Support Resources

TI E2E™ [support forums](#) are an engineer's go-to source for fast, verified answers and design help — straight from the experts. Search existing answers or ask your own question to get the quick design help you need.

Linked content is provided "AS IS" by the respective contributors. They do not constitute TI specifications and do not necessarily reflect TI's views; see TI's [Terms of Use](#).

### 11.3 Trademarks

TI E2E™ is a trademark of Texas Instruments.  
All trademarks are the property of their respective owners.

### 11.4 Electrostatic Discharge Caution



This integrated circuit can be damaged by ESD. Texas Instruments recommends that all integrated circuits be handled with appropriate precautions. Failure to observe proper handling and installation procedures can cause damage.

ESD damage can range from subtle performance degradation to complete device failure. Precision integrated circuits may be more susceptible to damage because very small parametric changes could cause the device not to meet its published specifications.

### 11.5 Glossary

[TI Glossary](#) This glossary lists and explains terms, acronyms, and definitions.

## 12 Mechanical, Packaging, and Orderable Information

The following pages include mechanical, packaging, and orderable information. This information is the most current data available for the designated devices. This data is subject to change without notice and revision of this document. For browser based versions of this data sheet, refer to the left hand navigation.

**PACKAGING INFORMATION**

Orderable Device	Status (1)	Package Type	Package Drawing	Pins	Package Qty	Eco Plan (2)	Lead finish/ Ball material (6)	MSL Peak Temp (3)	Op Temp (°C)	Device Marking (4/5)	Samples
LM193DR	ACTIVE	SOIC	D	8	2500	RoHS & Green	NIPDAU	Level-1-260C-UNLIM	-55 to 125	LM193	<a href="#">Samples</a>
LM193DRG4	ACTIVE	SOIC	D	8	2500	RoHS & Green	NIPDAU	Level-1-260C-UNLIM	-55 to 125	LM193	<a href="#">Samples</a>
LM2903AVQDR	ACTIVE	SOIC	D	8	2500	RoHS & Green	NIPDAU	Level-1-260C-UNLIM	-40 to 125	L2903AV	<a href="#">Samples</a>
LM2903AVQDRG4	ACTIVE	SOIC	D	8	2500	RoHS & Green	NIPDAU	Level-1-260C-UNLIM	-40 to 125	L2903AV	<a href="#">Samples</a>
LM2903AVQPWR	ACTIVE	TSSOP	PW	8	2000	RoHS & Green	NIPDAU	Level-1-260C-UNLIM	-40 to 125	L2903AV	<a href="#">Samples</a>
LM2903AVQPWRG4	ACTIVE	TSSOP	PW	8	2000	RoHS & Green	NIPDAU	Level-1-260C-UNLIM	-40 to 125	L2903AV	<a href="#">Samples</a>
LM2903BIDDFR	ACTIVE	SOT-23-THIN	DDF	8	3000	RoHS & Green	NIPDAU	Level-1-260C-UNLIM	-40 to 125	2903B	<a href="#">Samples</a>
LM2903BIDGKR	ACTIVE	VSSOP	DGK	8	2500	RoHS & Green	NIPDAU	Level-1-260C-UNLIM	-40 to 125	903B	<a href="#">Samples</a>
LM2903BIDR	ACTIVE	SOIC	D	8	2500	RoHS & Green	NIPDAU	Level-1-260C-UNLIM	-40 to 125	L2903B	<a href="#">Samples</a>
LM2903BIDSGR	ACTIVE	WSON	DSG	8	3000	RoHS & Green	NIPDAU	Level-1-260C-UNLIM	-40 to 125	903B	<a href="#">Samples</a>
LM2903BIPWR	ACTIVE	TSSOP	PW	8	2000	RoHS & Green	NIPDAU	Level-1-260C-UNLIM	-40 to 125	L2903B	<a href="#">Samples</a>
LM2903D	ACTIVE	SOIC	D	8	75	RoHS & Green	NIPDAU	Level-1-260C-UNLIM	-40 to 125	LM2903	<a href="#">Samples</a>
LM2903DE4	ACTIVE	SOIC	D	8	75	RoHS & Green	NIPDAU	Level-1-260C-UNLIM	-40 to 125	LM2903	<a href="#">Samples</a>
LM2903DG4	ACTIVE	SOIC	D	8	75	RoHS & Green	NIPDAU	Level-1-260C-UNLIM	-40 to 125	LM2903	<a href="#">Samples</a>
LM2903DGKR	ACTIVE	VSSOP	DGK	8	2500	RoHS & Green	NIPDAUAG   SN	Level-1-260C-UNLIM	-40 to 125	(MAP, MAS, MAU)	<a href="#">Samples</a>
LM2903DGKRG4	ACTIVE	VSSOP	DGK	8	2500	RoHS & Green	SN	Level-1-260C-UNLIM	-40 to 125	(MAP, MAS, MAU)	<a href="#">Samples</a>
LM2903DR	ACTIVE	SOIC	D	8	2500	RoHS & Green	NIPDAU   SN	Level-1-260C-UNLIM	-40 to 125	LM2903	<a href="#">Samples</a>
LM2903DRE4	ACTIVE	SOIC	D	8	2500	RoHS & Green	NIPDAU	Level-1-260C-UNLIM	-40 to 125	LM2903	<a href="#">Samples</a>
LM2903DRG3	ACTIVE	SOIC	D	8	2500	RoHS & Green	SN	Level-1-260C-UNLIM	-40 to 125	LM2903	<a href="#">Samples</a>
LM2903DRG4	ACTIVE	SOIC	D	8	2500	RoHS & Green	NIPDAU	Level-1-260C-UNLIM	-40 to 125	LM2903	<a href="#">Samples</a>

Orderable Device	Status (1)	Package Type	Package Drawing	Pins	Package Qty	Eco Plan (2)	Lead finish/ Ball material (6)	MSL Peak Temp (3)	Op Temp (°C)	Device Marking (4/5)	Samples
LM2903P	ACTIVE	PDIP	P	8	50	RoHS & Green	NIPDAU	N / A for Pkg Type	-40 to 125	LM2903P	<a href="#">Samples</a>
LM2903PSR	ACTIVE	SO	PS	8	2000	RoHS & Green	NIPDAU	Level-1-260C-UNLIM	-40 to 125	L2903	<a href="#">Samples</a>
LM2903PSRG4	ACTIVE	SO	PS	8	2000	TBD	Call TI	Call TI	-40 to 125		<a href="#">Samples</a>
LM2903PWR	ACTIVE	TSSOP	PW	8	2000	RoHS & Green	NIPDAU   SN	Level-1-260C-UNLIM	-40 to 125	L2903	<a href="#">Samples</a>
LM2903PWRG3	ACTIVE	TSSOP	PW	8	2000	RoHS & Green	SN	Level-1-260C-UNLIM	-40 to 125	L2903	<a href="#">Samples</a>
LM2903PWRG4	ACTIVE	TSSOP	PW	8	2000	RoHS & Green	NIPDAU	Level-1-260C-UNLIM	-40 to 125	L2903	<a href="#">Samples</a>
LM2903QD	ACTIVE	SOIC	D	8	75	RoHS & Green	NIPDAU	Level-1-260C-UNLIM	-40 to 125	2903Q	<a href="#">Samples</a>
LM2903QDG4	ACTIVE	SOIC	D	8	75	RoHS & Green	NIPDAU	Level-1-260C-UNLIM	-40 to 125	2903Q	<a href="#">Samples</a>
LM2903QDRG4	ACTIVE	SOIC	D	8	2500	RoHS & Green	NIPDAU	Level-1-260C-UNLIM	-40 to 125	2903Q	<a href="#">Samples</a>
LM2903VQDR	ACTIVE	SOIC	D	8	2500	RoHS & Green	NIPDAU	Level-1-260C-UNLIM	-40 to 125	L2903V	<a href="#">Samples</a>
LM2903VQDRG4	ACTIVE	SOIC	D	8	2500	RoHS & Green	NIPDAU	Level-1-260C-UNLIM	-40 to 125	L2903V	<a href="#">Samples</a>
LM2903VQPWR	ACTIVE	TSSOP	PW	8	2000	RoHS & Green	NIPDAU	Level-1-260C-UNLIM	-40 to 125	L2903V	<a href="#">Samples</a>
LM2903VQPWRG4	ACTIVE	TSSOP	PW	8	2000	RoHS & Green	NIPDAU	Level-1-260C-UNLIM	-40 to 125	L2903V	<a href="#">Samples</a>
LM293AD	ACTIVE	SOIC	D	8	75	RoHS & Green	NIPDAU	Level-1-260C-UNLIM	-25 to 85	LM293A	<a href="#">Samples</a>
LM293ADE4	ACTIVE	SOIC	D	8	75	RoHS & Green	NIPDAU	Level-1-260C-UNLIM	-25 to 85	LM293A	<a href="#">Samples</a>
LM293ADGKR	ACTIVE	VSSOP	DGK	8	2500	RoHS & Green	NIPDAU   SN   NIPDAUAG	Level-1-260C-UNLIM	-25 to 85	(MDP, MDS, MDU)	<a href="#">Samples</a>
LM293ADGKRG4	ACTIVE	VSSOP	DGK	8	2500	RoHS & Green	SN	Level-1-260C-UNLIM	-25 to 85	(MDP, MDS, MDU)	<a href="#">Samples</a>
LM293ADR	ACTIVE	SOIC	D	8	2500	RoHS & Green	NIPDAU   SN	Level-1-260C-UNLIM	-25 to 85	LM293A	<a href="#">Samples</a>
LM293ADRG4	ACTIVE	SOIC	D	8	2500	RoHS & Green	NIPDAU	Level-1-260C-UNLIM	-25 to 85	LM293A	<a href="#">Samples</a>
LM293D	ACTIVE	SOIC	D	8	75	RoHS & Green	NIPDAU	Level-1-260C-UNLIM	-25 to 85	LM293	<a href="#">Samples</a>
LM293DGKR	ACTIVE	VSSOP	DGK	8	2500	RoHS & Green	NIPDAU   SN   NIPDAUAG	Level-1-260C-UNLIM	-25 to 85	(MCP, MCS, MCU)	<a href="#">Samples</a>



Orderable Device	Status (1)	Package Type	Package Drawing	Pins	Package Qty	Eco Plan (2)	Lead finish/ Ball material (6)	MSL Peak Temp (3)	Op Temp (°C)	Device Marking (4/5)	Samples
LM293DGKRG4	ACTIVE	VSSOP	DGK	8	2500	RoHS & Green	SN	Level-1-260C-UNLIM	-25 to 85	(MCP, MCS, MCU)	<a href="#">Samples</a>
LM293DR	ACTIVE	SOIC	D	8	2500	RoHS & Green	NIPDAU   SN	Level-1-260C-UNLIM	-25 to 85	LM293	<a href="#">Samples</a>
LM293DRE4	ACTIVE	SOIC	D	8	2500	RoHS & Green	NIPDAU	Level-1-260C-UNLIM	-25 to 85	LM293	<a href="#">Samples</a>
LM293DRG3	ACTIVE	SOIC	D	8	2500	RoHS & Green	SN	Level-1-260C-UNLIM	-25 to 85	LM293	<a href="#">Samples</a>
LM293DRG4	ACTIVE	SOIC	D	8	2500	RoHS & Green	NIPDAU	Level-1-260C-UNLIM	-25 to 85	LM293	<a href="#">Samples</a>
LM293P	ACTIVE	PDIP	P	8	50	RoHS & Green	NIPDAU   SN	N / A for Pkg Type	-25 to 85	LM293P	<a href="#">Samples</a>
LM293PE4	ACTIVE	PDIP	P	8	50	RoHS & Green	NIPDAU	N / A for Pkg Type	-25 to 85	LM293P	<a href="#">Samples</a>
LM393AD	ACTIVE	SOIC	D	8	75	RoHS & Green	NIPDAU	Level-1-260C-UNLIM	0 to 70	LM393A	<a href="#">Samples</a>
LM393ADE4	ACTIVE	SOIC	D	8	75	RoHS & Green	NIPDAU	Level-1-260C-UNLIM	0 to 70	LM393A	<a href="#">Samples</a>
LM393ADG4	ACTIVE	SOIC	D	8	75	RoHS & Green	NIPDAU	Level-1-260C-UNLIM	0 to 70	LM393A	<a href="#">Samples</a>
LM393ADGKR	ACTIVE	VSSOP	DGK	8	2500	RoHS & Green	NIPDAU   NIPDAUAG	Level-1-260C-UNLIM	0 to 70	(M8P, M8S, M8U)	<a href="#">Samples</a>
LM393ADGKRG4	ACTIVE	VSSOP	DGK	8	2500	RoHS & Green	NIPDAU	Level-1-260C-UNLIM	0 to 70	(M8P, M8S, M8U)	<a href="#">Samples</a>
LM393ADR	ACTIVE	SOIC	D	8	2500	RoHS & Green	NIPDAU   SN	Level-1-260C-UNLIM	0 to 70	LM393A	<a href="#">Samples</a>
LM393ADRE4	ACTIVE	SOIC	D	8	2500	RoHS & Green	NIPDAU	Level-1-260C-UNLIM	0 to 70	LM393A	<a href="#">Samples</a>
LM393ADRG4	ACTIVE	SOIC	D	8	2500	RoHS & Green	NIPDAU	Level-1-260C-UNLIM	0 to 70	LM393A	<a href="#">Samples</a>
LM393AP	ACTIVE	PDIP	P	8	50	RoHS & Green	NIPDAU   SN	N / A for Pkg Type	0 to 70	LM393AP	<a href="#">Samples</a>
LM393APE4	ACTIVE	PDIP	P	8	50	RoHS & Green	NIPDAU	N / A for Pkg Type	0 to 70	LM393AP	<a href="#">Samples</a>
LM393APSR	ACTIVE	SO	PS	8	2000	RoHS & Green	NIPDAU	Level-1-260C-UNLIM	0 to 70	L393A	<a href="#">Samples</a>
LM393APWR	ACTIVE	TSSOP	PW	8	2000	RoHS & Green	NIPDAU   SN	Level-1-260C-UNLIM	0 to 70	L393A	<a href="#">Samples</a>
LM393APWRE4	ACTIVE	TSSOP	PW	8	2000	RoHS & Green	NIPDAU	Level-1-260C-UNLIM	0 to 70	L393A	<a href="#">Samples</a>
LM393APWRG4	ACTIVE	TSSOP	PW	8	2000	RoHS & Green	NIPDAU	Level-1-260C-UNLIM	0 to 70	L393A	<a href="#">Samples</a>

Orderable Device	Status (1)	Package Type	Package Drawing	Pins	Package Qty	Eco Plan (2)	Lead finish/ Ball material (6)	MSL Peak Temp (3)	Op Temp (°C)	Device Marking (4/5)	Samples
LM393BIDDFR	ACTIVE	SOT-23-THIN	DDF	8	3000	RoHS & Green	NIPDAU	Level-1-260C-UNLIM	-40 to 85	393B	<a href="#">Samples</a>
LM393BIDGKR	ACTIVE	VSSOP	DGK	8	2500	RoHS & Green	NIPDAU	Level-1-260C-UNLIM	-40 to 85	393B	<a href="#">Samples</a>
LM393BIDR	ACTIVE	SOIC	D	8	2500	RoHS & Green	NIPDAU	Level-1-260C-UNLIM	-40 to 85	LM393B	<a href="#">Samples</a>
LM393BIDSGR	ACTIVE	WSON	DSG	8	3000	RoHS & Green	NIPDAU	Level-1-260C-UNLIM	-40 to 85	393B	<a href="#">Samples</a>
LM393BIPWR	ACTIVE	TSSOP	PW	8	2000	RoHS & Green	NIPDAU	Level-1-260C-UNLIM	-40 to 85	LM393B	<a href="#">Samples</a>
LM393D	ACTIVE	SOIC	D	8	75	RoHS & Green	NIPDAU	Level-1-260C-UNLIM	0 to 70	LM393	<a href="#">Samples</a>
LM393DE4	ACTIVE	SOIC	D	8	75	RoHS & Green	NIPDAU	Level-1-260C-UNLIM	0 to 70	LM393	<a href="#">Samples</a>
LM393DG4	ACTIVE	SOIC	D	8	75	RoHS & Green	NIPDAU	Level-1-260C-UNLIM	0 to 70	LM393	<a href="#">Samples</a>
LM393DGKR	ACTIVE	VSSOP	DGK	8	2500	RoHS & Green	NIPDAU   SN   NIPDAUAG	Level-1-260C-UNLIM	0 to 70	(M9P, M9S, M9U)	<a href="#">Samples</a>
LM393DGKRG4	ACTIVE	VSSOP	DGK	8	2500	RoHS & Green	SN	Level-1-260C-UNLIM	0 to 70	(M9P, M9S, M9U)	<a href="#">Samples</a>
LM393DR	ACTIVE	SOIC	D	8	2500	RoHS & Green	NIPDAU   SN	Level-1-260C-UNLIM	0 to 70	LM393	<a href="#">Samples</a>
LM393DRE4	ACTIVE	SOIC	D	8	2500	RoHS & Green	NIPDAU	Level-1-260C-UNLIM	0 to 70	LM393	<a href="#">Samples</a>
LM393DRG3	ACTIVE	SOIC	D	8	2500	RoHS & Green	SN	Level-1-260C-UNLIM	0 to 70	LM393	<a href="#">Samples</a>
LM393DRG4	ACTIVE	SOIC	D	8	2500	RoHS & Green	NIPDAU	Level-1-260C-UNLIM	0 to 70	LM393	<a href="#">Samples</a>
LM393P	ACTIVE	PDIP	P	8	50	RoHS & Green	NIPDAU   SN	N / A for Pkg Type	0 to 70	LM393P	<a href="#">Samples</a>
LM393PE3	ACTIVE	PDIP	P	8	50	RoHS & Non-Green	SN	N / A for Pkg Type	0 to 70	LM393P	<a href="#">Samples</a>
LM393PE4	ACTIVE	PDIP	P	8	50	RoHS & Green	NIPDAU	N / A for Pkg Type	0 to 70	LM393P	<a href="#">Samples</a>
LM393PSR	ACTIVE	SO	PS	8	2000	RoHS & Green	NIPDAU	Level-1-260C-UNLIM	0 to 70	L393	<a href="#">Samples</a>
LM393PSRG4	ACTIVE	SO	PS	8	2000	RoHS & Green	NIPDAU	Level-1-260C-UNLIM	0 to 70	L393	<a href="#">Samples</a>
LM393PW	ACTIVE	TSSOP	PW	8	150	RoHS & Green	NIPDAU	Level-1-260C-UNLIM	0 to 70	L393	<a href="#">Samples</a>
LM393PWG4	ACTIVE	TSSOP	PW	8	150	RoHS & Green	NIPDAU	Level-1-260C-UNLIM	0 to 70	L393	<a href="#">Samples</a>

Orderable Device	Status (1)	Package Type	Package Drawing	Pins	Package Qty	Eco Plan (2)	Lead finish/ Ball material (6)	MSL Peak Temp (3)	Op Temp (°C)	Device Marking (4/5)	Samples
LM393PWR	ACTIVE	TSSOP	PW	8	2000	RoHS & Green	NIPDAU   SN	Level-1-260C-UNLIM	0 to 70	L393	<a href="#">Samples</a>
LM393PWRG3	ACTIVE	TSSOP	PW	8	2000	RoHS & Green	SN	Level-1-260C-UNLIM	0 to 70	L393	<a href="#">Samples</a>
LM393PWRG4	ACTIVE	TSSOP	PW	8	2000	RoHS & Green	NIPDAU	Level-1-260C-UNLIM	0 to 70	L393	<a href="#">Samples</a>

(1) The marketing status values are defined as follows:

**ACTIVE:** Product device recommended for new designs.

**LIFEBUY:** TI has announced that the device will be discontinued, and a lifetime-buy period is in effect.

**NRND:** Not recommended for new designs. Device is in production to support existing customers, but TI does not recommend using this part in a new design.

**PREVIEW:** Device has been announced but is not in production. Samples may or may not be available.

**OBSELETE:** TI has discontinued the production of the device.

(2) **RoHS:** TI defines "RoHS" to mean semiconductor products that are compliant with the current EU RoHS requirements for all 10 RoHS substances, including the requirement that RoHS substance do not exceed 0.1% by weight in homogeneous materials. Where designed to be soldered at high temperatures, "RoHS" products are suitable for use in specified lead-free processes. TI may reference these types of products as "Pb-Free".

**RoHS Exempt:** TI defines "RoHS Exempt" to mean products that contain lead but are compliant with EU RoHS pursuant to a specific EU RoHS exemption.

**Green:** TI defines "Green" to mean the content of Chlorine (Cl) and Bromine (Br) based flame retardants meet JS709B low halogen requirements of <=1000ppm threshold. Antimony trioxide based flame retardants must also meet the <=1000ppm threshold requirement.

(3) MSL, Peak Temp. - The Moisture Sensitivity Level rating according to the JEDEC industry standard classifications, and peak solder temperature.

(4) There may be additional marking, which relates to the logo, the lot trace code information, or the environmental category on the device.

(5) Multiple Device Markings will be inside parentheses. Only one Device Marking contained in parentheses and separated by a "-" will appear on a device. If a line is indented then it is a continuation of the previous line and the two combined represent the entire Device Marking for that device.

(6) Lead finish/Ball material - Orderable Devices may have multiple material finish options. Finish options are separated by a vertical ruled line. Lead finish/Ball material values may wrap to two lines if the finish value exceeds the maximum column width.

**Important Information and Disclaimer:**The information provided on this page represents TI's knowledge and belief as of the date that it is provided. TI bases its knowledge and belief on information provided by third parties, and makes no representation or warranty as to the accuracy of such information. Efforts are underway to better integrate information from third parties. TI has taken and continues to take reasonable steps to provide representative and accurate information but may not have conducted destructive testing or chemical analysis on incoming materials and chemicals. TI and TI suppliers consider certain information to be proprietary, and thus CAS numbers and other limited information may not be available for release.

In no event shall TI's liability arising out of such information exceed the total purchase price of the TI part(s) at issue in this document sold by TI to Customer on an annual basis.

**OTHER QUALIFIED VERSIONS OF LM2903, LM2903B, LM293 :**

- Automotive : [LM2903-Q1](#), [LM2903B-Q1](#)
- Enhanced Product : [LM293-EP](#)

## NOTE: Qualified Version Definitions:

- Automotive - Q100 devices qualified for high-reliability automotive applications targeting zero defects
- Enhanced Product - Supports Defense, Aerospace and Medical Applications

**TAPE AND REEL INFORMATION**

**QUADRANT ASSIGNMENTS FOR PIN 1 ORIENTATION IN TAPE**

\*All dimensions are nominal

Device	Package Type	Package Drawing	Pins	SPQ	Reel Diameter (mm)	Reel Width W1 (mm)	A0 (mm)	B0 (mm)	K0 (mm)	P1 (mm)	W (mm)	Pin1 Quadrant
LM193DR	SOIC	D	8	2500	330.0	12.4	6.4	5.2	2.1	8.0	12.0	Q1
LM2903AVQDR	SOIC	D	8	2500	330.0	12.4	6.4	5.2	2.1	8.0	12.0	Q1
LM2903AVQDR	SOIC	D	8	2500	330.0	12.5	6.4	5.2	2.1	8.0	12.0	Q1
LM2903AVQDRG4	SOIC	D	8	2500	330.0	12.4	6.4	5.2	2.1	8.0	12.0	Q1
LM2903AVQPWR	TSSOP	PW	8	2000	330.0	12.4	7.0	3.6	1.6	8.0	12.0	Q1
LM2903AVQPWRG4	TSSOP	PW	8	2000	330.0	12.4	7.0	3.6	1.6	8.0	12.0	Q1
LM2903BIDDFR	SOT-23-THIN	DDF	8	3000	180.0	8.4	3.2	3.2	1.4	4.0	8.0	Q3
LM2903BIDGKR	VSSOP	DGK	8	2500	330.0	12.4	5.3	3.4	1.4	8.0	12.0	Q1
LM2903BIDR	SOIC	D	8	2500	330.0	12.4	6.4	5.2	2.1	8.0	12.0	Q1
LM2903BIDSGR	WSON	DSG	8	3000	180.0	8.4	2.3	2.3	1.15	4.0	8.0	Q2
LM2903BIPWR	TSSOP	PW	8	2000	330.0	12.4	7.0	3.6	1.6	8.0	12.0	Q1
LM2903DGKR	VSSOP	DGK	8	2500	330.0	12.4	5.3	3.4	1.4	8.0	12.0	Q1
LM2903DGKR	VSSOP	DGK	8	2500	330.0	12.4	5.3	3.4	1.4	8.0	12.0	Q1
LM2903DR	SOIC	D	8	2500	330.0	12.4	6.4	5.2	2.1	8.0	12.0	Q1
LM2903DR	SOIC	D	8	2500	330.0	12.4	6.4	5.2	2.1	8.0	12.0	Q1

Device	Package Type	Package Drawing	Pins	SPQ	Reel Diameter (mm)	Reel Width W1 (mm)	A0 (mm)	B0 (mm)	K0 (mm)	P1 (mm)	W (mm)	Pin1 Quadrant
LM2903DR	SOIC	D	8	2500	330.0	12.4	6.4	5.2	2.1	8.0	12.0	Q1
LM2903DR	SOIC	D	8	2500	330.0	12.8	6.4	5.2	2.1	8.0	12.0	Q1
LM2903DR	SOIC	D	8	2500	330.0	12.4	6.4	5.2	2.1	8.0	12.0	Q1
LM2903DRG3	SOIC	D	8	2500	330.0	12.8	6.4	5.2	2.1	8.0	12.0	Q1
LM2903DRG4	SOIC	D	8	2500	330.0	12.4	6.4	5.2	2.1	8.0	12.0	Q1
LM2903DRG4	SOIC	D	8	2500	330.0	12.4	6.4	5.2	2.1	8.0	12.0	Q1
LM2903DRG4	SOIC	D	8	2500	330.0	12.4	6.4	5.2	2.1	8.0	12.0	Q1
LM2903DRG4	SOIC	D	8	2500	330.0	12.4	6.4	5.2	2.1	8.0	12.0	Q1
LM2903PSR	SO	PS	8	2000	330.0	16.4	8.35	6.6	2.4	12.0	16.0	Q1
LM2903PWR	TSSOP	PW	8	2000	330.0	12.4	7.0	3.6	1.6	8.0	12.0	Q1
LM2903PWR	TSSOP	PW	8	2000	330.0	12.4	7.0	3.6	1.6	8.0	12.0	Q1
LM2903PWR	TSSOP	PW	8	2000	330.0	12.4	7.0	3.6	1.6	8.0	12.0	Q1
LM2903PWRG3	TSSOP	PW	8	2000	330.0	12.4	7.0	3.6	1.6	8.0	12.0	Q1
LM2903PWRG4	TSSOP	PW	8	2000	330.0	12.4	7.0	3.6	1.6	8.0	12.0	Q1
LM2903QDRG4	SOIC	D	8	2500	330.0	12.4	6.4	5.2	2.1	8.0	12.0	Q1
LM2903VQDR	SOIC	D	8	2500	330.0	12.4	6.4	5.2	2.1	8.0	12.0	Q1
LM2903VQDR	SOIC	D	8	2500	330.0	12.5	6.4	5.2	2.1	8.0	12.0	Q1
LM2903VQDRG4	SOIC	D	8	2500	330.0	12.4	6.4	5.2	2.1	8.0	12.0	Q1
LM2903VQPWR	TSSOP	PW	8	2000	330.0	12.4	7.0	3.6	1.6	8.0	12.0	Q1
LM2903VQPWR	TSSOP	PW	8	2000	330.0	12.4	7.0	3.6	1.6	8.0	12.0	Q1
LM2903VQPWRG4	TSSOP	PW	8	2000	330.0	12.4	7.0	3.6	1.6	8.0	12.0	Q1
LM293ADGKR	VSSOP	DGK	8	2500	330.0	12.4	5.3	3.4	1.4	8.0	12.0	Q1
LM293ADGKR	VSSOP	DGK	8	2500	330.0	12.4	5.3	3.4	1.4	8.0	12.0	Q1
LM293ADGKR	VSSOP	DGK	8	2500	330.0	12.4	5.3	3.3	1.3	8.0	12.0	Q1
LM293ADGKR	VSSOP	DGK	8	2500	330.0	12.4	5.3	3.4	1.4	8.0	12.0	Q1
LM293ADR	SOIC	D	8	2500	330.0	12.4	6.4	5.2	2.1	8.0	12.0	Q1
LM293ADR	SOIC	D	8	2500	330.0	12.4	6.4	5.2	2.1	8.0	12.0	Q1
LM293ADR	SOIC	D	8	2500	330.0	12.4	6.4	5.2	2.1	8.0	12.0	Q1
LM293ADR	SOIC	D	8	2500	330.0	12.8	6.4	5.2	2.1	8.0	12.0	Q1
LM293ADR	SOIC	D	8	2500	330.0	12.4	6.4	5.2	2.1	8.0	12.0	Q1
LM293ADRG4	SOIC	D	8	2500	330.0	12.4	6.4	5.2	2.1	8.0	12.0	Q1
LM293ADRG4	SOIC	D	8	2500	330.0	12.4	6.4	5.2	2.1	8.0	12.0	Q1
LM293ADRG4	SOIC	D	8	2500	330.0	12.4	6.4	5.2	2.1	8.0	12.0	Q1
LM293ADRG4	SOIC	D	8	2500	330.0	12.4	6.4	5.2	2.1	8.0	12.0	Q1
LM293ADRG4	SOIC	D	8	2500	330.0	12.4	6.4	5.2	2.1	8.0	12.0	Q1
LM293DGKR	VSSOP	DGK	8	2500	330.0	12.4	5.3	3.4	1.4	8.0	12.0	Q1
LM293DGKR	VSSOP	DGK	8	2500	330.0	12.4	5.3	3.4	1.4	8.0	12.0	Q1
LM293DR	SOIC	D	8	2500	330.0	12.8	6.4	5.2	2.1	8.0	12.0	Q1
LM293DR	SOIC	D	8	2500	330.0	12.4	6.4	5.2	2.1	8.0	12.0	Q1
LM293DR	SOIC	D	8	2500	330.0	12.4	6.4	5.2	2.1	8.0	12.0	Q1
LM293DRG3	SOIC	D	8	2500	330.0	12.8	6.4	5.2	2.1	8.0	12.0	Q1
LM293DRG4	SOIC	D	8	2500	330.0	12.4	6.4	5.2	2.1	8.0	12.0	Q1

Device	Package Type	Package Drawing	Pins	SPQ	Reel Diameter (mm)	Reel Width W1 (mm)	A0 (mm)	B0 (mm)	K0 (mm)	P1 (mm)	W (mm)	Pin1 Quadrant
LM293DRG4	SOIC	D	8	2500	330.0	12.4	6.4	5.2	2.1	8.0	12.0	Q1
LM293DRG4	SOIC	D	8	2500	330.0	12.4	6.4	5.2	2.1	8.0	12.0	Q1
LM293DRG4	SOIC	D	8	2500	330.0	12.4	6.4	5.2	2.1	8.0	12.0	Q1
LM393ADGKR	VSSOP	DGK	8	2500	330.0	12.4	5.3	3.3	1.3	8.0	12.0	Q1
LM393ADGKR	VSSOP	DGK	8	2500	330.0	12.4	5.3	3.4	1.4	8.0	12.0	Q1
LM393ADGKR	VSSOP	DGK	8	2500	330.0	12.4	5.3	3.4	1.4	8.0	12.0	Q1
LM393ADR	SOIC	D	8	2500	330.0	12.4	6.4	5.2	2.1	8.0	12.0	Q1
LM393ADR	SOIC	D	8	2500	330.0	12.8	6.4	5.2	2.1	8.0	12.0	Q1
LM393ADR	SOIC	D	8	2500	330.0	12.4	6.4	5.2	2.1	8.0	12.0	Q1
LM393ADR	SOIC	D	8	2500	330.0	12.4	6.4	5.2	2.1	8.0	12.0	Q1
LM393ADR	SOIC	D	8	2500	330.0	12.4	6.4	5.2	2.1	8.0	12.0	Q1
LM393ADRG4	SOIC	D	8	2500	330.0	12.4	6.4	5.2	2.1	8.0	12.0	Q1
LM393ADRG4	SOIC	D	8	2500	330.0	12.4	6.4	5.2	2.1	8.0	12.0	Q1
LM393ADRG4	SOIC	D	8	2500	330.0	12.4	6.4	5.2	2.1	8.0	12.0	Q1
LM393ADRG4	SOIC	D	8	2500	330.0	12.4	6.4	5.2	2.1	8.0	12.0	Q1
LM393ADRG4	SOIC	D	8	2500	330.0	12.4	6.4	5.2	2.1	8.0	12.0	Q1
LM393APSR	SO	PS	8	2000	330.0	16.4	8.35	6.6	2.4	12.0	16.0	Q1
LM393APWR	TSSOP	PW	8	2000	330.0	12.4	7.0	3.6	1.6	8.0	12.0	Q1
LM393APWR	TSSOP	PW	8	2000	330.0	12.4	7.0	3.6	1.6	8.0	12.0	Q1
LM393APWR	TSSOP	PW	8	2000	330.0	12.4	7.0	3.6	1.6	8.0	12.0	Q1
LM393APWRG4	TSSOP	PW	8	2000	330.0	12.4	7.0	3.6	1.6	8.0	12.0	Q1
LM393BIDDFR	SOT-23-THIN	DDF	8	3000	180.0	8.4	3.2	3.2	1.4	4.0	8.0	Q3
LM393BIDGKR	VSSOP	DGK	8	2500	330.0	12.4	5.3	3.4	1.4	8.0	12.0	Q1
LM393BIDR	SOIC	D	8	2500	330.0	12.4	6.4	5.2	2.1	8.0	12.0	Q1
LM393BIDSGR	WSON	DSG	8	3000	180.0	8.4	2.3	2.3	1.15	4.0	8.0	Q2
LM393BIPWR	TSSOP	PW	8	2000	330.0	12.4	7.0	3.6	1.6	8.0	12.0	Q1
LM393DGKR	VSSOP	DGK	8	2500	330.0	12.4	5.3	3.4	1.4	8.0	12.0	Q1
LM393DGKR	VSSOP	DGK	8	2500	330.0	12.4	5.3	3.4	1.4	8.0	12.0	Q1
LM393DR	SOIC	D	8	2500	330.0	12.4	6.4	5.2	2.1	8.0	12.0	Q1
LM393DR	SOIC	D	8	2500	330.0	12.4	6.4	5.2	2.1	8.0	12.0	Q1
LM393DR	SOIC	D	8	2500	330.0	12.4	6.4	5.2	2.1	8.0	12.0	Q1
LM393DR	SOIC	D	8	2500	330.0	12.4	6.4	5.2	2.1	8.0	12.0	Q1
LM393DRG3	SOIC	D	8	2500	330.0	12.8	6.4	5.2	2.1	8.0	12.0	Q1
LM393DRG3	SOIC	D	8	2500	330.0	15.4	6.4	5.2	2.1	8.0	12.0	Q1
LM393DRG4	SOIC	D	8	2500	330.0	12.4	6.4	5.2	2.1	8.0	12.0	Q1
LM393DRG4	SOIC	D	8	2500	330.0	12.4	6.4	5.2	2.1	8.0	12.0	Q1
LM393DRG4	SOIC	D	8	2500	330.0	12.4	6.4	5.2	2.1	8.0	12.0	Q1
LM393DRG4	SOIC	D	8	2500	330.0	12.4	6.4	5.2	2.1	8.0	12.0	Q1
LM393DRG4	SOIC	D	8	2500	330.0	12.4	6.4	5.2	2.1	8.0	12.0	Q1
LM393PSR	SO	PS	8	2000	330.0	16.4	8.35	6.6	2.4	12.0	16.0	Q1
LM393PWR	TSSOP	PW	8	2000	330.0	12.4	7.0	3.6	1.6	8.0	12.0	Q1
LM393PWR	TSSOP	PW	8	2000	330.0	12.4	7.0	3.6	1.6	8.0	12.0	Q1
LM393PWRG3	TSSOP	PW	8	2000	330.0	12.4	7.0	3.6	1.6	8.0	12.0	Q1

Device	Package Type	Package Drawing	Pins	SPQ	Reel Diameter (mm)	Reel Width W1 (mm)	A0 (mm)	B0 (mm)	K0 (mm)	P1 (mm)	W (mm)	Pin1 Quadrant
LM393PWRG4	TSSOP	PW	8	2000	330.0	12.4	7.0	3.6	1.6	8.0	12.0	Q1



**TAPE AND REEL BOX DIMENSIONS**

\*All dimensions are nominal

Device	Package Type	Package Drawing	Pins	SPQ	Length (mm)	Width (mm)	Height (mm)
LM193DR	SOIC	D	8	2500	350.0	350.0	43.0
LM2903AVQDR	SOIC	D	8	2500	340.5	338.1	20.6
LM2903AVQDR	SOIC	D	8	2500	340.5	336.1	25.0
LM2903AVQDRG4	SOIC	D	8	2500	340.5	338.1	20.6
LM2903AVQPWR	TSSOP	PW	8	2000	356.0	356.0	35.0
LM2903AVQPWRG4	TSSOP	PW	8	2000	356.0	356.0	35.0
LM2903BIDDFR	SOT-23-THIN	DDF	8	3000	210.0	185.0	35.0
LM2903BIDGKR	VSSOP	DGK	8	2500	366.0	364.0	50.0
LM2903BIDR	SOIC	D	8	2500	340.5	336.1	25.0
LM2903BIDSGR	WSON	DSG	8	3000	210.0	185.0	35.0
LM2903BIPWR	TSSOP	PW	8	2000	356.0	356.0	35.0
LM2903DGKR	VSSOP	DGK	8	2500	364.0	364.0	27.0
LM2903DGKR	VSSOP	DGK	8	2500	366.0	364.0	50.0
LM2903DR	SOIC	D	8	2500	340.5	338.1	20.6
LM2903DR	SOIC	D	8	2500	340.5	338.1	20.6
LM2903DR	SOIC	D	8	2500	356.0	356.0	35.0
LM2903DR	SOIC	D	8	2500	364.0	364.0	27.0
LM2903DR	SOIC	D	8	2500	356.0	356.0	35.0

Device	Package Type	Package Drawing	Pins	SPQ	Length (mm)	Width (mm)	Height (mm)
LM2903DRG3	SOIC	D	8	2500	364.0	364.0	27.0
LM2903DRG4	SOIC	D	8	2500	340.5	338.1	20.6
LM2903DRG4	SOIC	D	8	2500	356.0	356.0	35.0
LM2903DRG4	SOIC	D	8	2500	340.5	336.1	25.0
LM2903DRG4	SOIC	D	8	2500	356.0	356.0	35.0
LM2903PSR	SO	PS	8	2000	356.0	356.0	35.0
LM2903PWR	TSSOP	PW	8	2000	356.0	356.0	35.0
LM2903PWR	TSSOP	PW	8	2000	356.0	356.0	35.0
LM2903PWR	TSSOP	PW	8	2000	364.0	364.0	27.0
LM2903PWRG3	TSSOP	PW	8	2000	364.0	364.0	27.0
LM2903PWRG4	TSSOP	PW	8	2000	356.0	356.0	35.0
LM2903QDRG4	SOIC	D	8	2500	350.0	350.0	43.0
LM2903VQDR	SOIC	D	8	2500	340.5	338.1	20.6
LM2903VQDR	SOIC	D	8	2500	340.5	338.1	20.6
LM2903VQDRG4	SOIC	D	8	2500	340.5	338.1	20.6
LM2903VQPWR	TSSOP	PW	8	2000	356.0	356.0	35.0
LM2903VQPWR	TSSOP	PW	8	2000	356.0	356.0	35.0
LM2903VQPWRG4	TSSOP	PW	8	2000	356.0	356.0	35.0
LM293ADGKR	VSSOP	DGK	8	2500	358.0	335.0	35.0
LM293ADGKR	VSSOP	DGK	8	2500	364.0	364.0	27.0
LM293ADGKR	VSSOP	DGK	8	2500	370.0	355.0	55.0
LM293ADGKR	VSSOP	DGK	8	2500	366.0	364.0	50.0
LM293ADR	SOIC	D	8	2500	340.5	338.1	20.6
LM293ADR	SOIC	D	8	2500	356.0	356.0	35.0
LM293ADR	SOIC	D	8	2500	340.5	336.1	25.0
LM293ADR	SOIC	D	8	2500	364.0	364.0	27.0
LM293ADR	SOIC	D	8	2500	356.0	356.0	35.0
LM293ADRG4	SOIC	D	8	2500	356.0	356.0	35.0
LM293ADRG4	SOIC	D	8	2500	340.5	336.1	25.0
LM293ADRG4	SOIC	D	8	2500	356.0	356.0	35.0
LM293ADRG4	SOIC	D	8	2500	340.5	338.1	20.6
LM293DGKR	VSSOP	DGK	8	2500	364.0	364.0	27.0
LM293DGKR	VSSOP	DGK	8	2500	366.0	364.0	50.0
LM293DR	SOIC	D	8	2500	364.0	364.0	27.0
LM293DR	SOIC	D	8	2500	356.0	356.0	35.0
LM293DR	SOIC	D	8	2500	356.0	356.0	35.0
LM293DRG3	SOIC	D	8	2500	364.0	364.0	27.0
LM293DRG4	SOIC	D	8	2500	356.0	356.0	35.0
LM293DRG4	SOIC	D	8	2500	356.0	356.0	35.0
LM293DRG4	SOIC	D	8	2500	340.5	336.1	25.0
LM293DRG4	SOIC	D	8	2500	340.5	338.1	20.6
LM393ADGKR	VSSOP	DGK	8	2500	346.0	346.0	35.0
LM393ADGKR	VSSOP	DGK	8	2500	358.0	335.0	35.0

Device	Package Type	Package Drawing	Pins	SPQ	Length (mm)	Width (mm)	Height (mm)
LM393ADGKR	VSSOP	DGK	8	2500	364.0	364.0	27.0
LM393ADR	SOIC	D	8	2500	340.5	336.1	25.0
LM393ADR	SOIC	D	8	2500	364.0	364.0	27.0
LM393ADR	SOIC	D	8	2500	340.5	338.1	20.6
LM393ADR	SOIC	D	8	2500	356.0	356.0	35.0
LM393ADR	SOIC	D	8	2500	356.0	356.0	35.0
LM393ADRG4	SOIC	D	8	2500	356.0	356.0	35.0
LM393ADRG4	SOIC	D	8	2500	340.5	336.1	25.0
LM393ADRG4	SOIC	D	8	2500	356.0	356.0	35.0
LM393ADRG4	SOIC	D	8	2500	340.5	338.1	20.6
LM393APSR	SO	PS	8	2000	356.0	356.0	35.0
LM393APWR	TSSOP	PW	8	2000	364.0	364.0	27.0
LM393APWR	TSSOP	PW	8	2000	356.0	356.0	35.0
LM393APWR	TSSOP	PW	8	2000	356.0	356.0	35.0
LM393APWRG4	TSSOP	PW	8	2000	356.0	356.0	35.0
LM393BIDDFR	SOT-23-THIN	DDF	8	3000	210.0	185.0	35.0
LM393BIDGKR	VSSOP	DGK	8	2500	366.0	364.0	50.0
LM393BIDR	SOIC	D	8	2500	340.5	336.1	25.0
LM393BIDSGR	WSON	DSG	8	3000	210.0	185.0	35.0
LM393BIPWR	TSSOP	PW	8	2000	356.0	356.0	35.0
LM393DGKR	VSSOP	DGK	8	2500	364.0	364.0	27.0
LM393DGKR	VSSOP	DGK	8	2500	366.0	364.0	50.0
LM393DR	SOIC	D	8	2500	340.5	338.1	20.6
LM393DR	SOIC	D	8	2500	340.5	338.1	25.0
LM393DR	SOIC	D	8	2500	356.0	356.0	35.0
LM393DR	SOIC	D	8	2500	356.0	356.0	35.0
LM393DRG3	SOIC	D	8	2500	364.0	364.0	27.0
LM393DRG3	SOIC	D	8	2500	333.2	345.9	28.6
LM393DRG4	SOIC	D	8	2500	340.5	338.1	20.6
LM393DRG4	SOIC	D	8	2500	356.0	356.0	35.0
LM393DRG4	SOIC	D	8	2500	340.5	336.1	25.0
LM393DRG4	SOIC	D	8	2500	356.0	356.0	35.0
LM393PSR	SO	PS	8	2000	356.0	356.0	35.0
LM393PWR	TSSOP	PW	8	2000	364.0	364.0	27.0
LM393PWR	TSSOP	PW	8	2000	356.0	356.0	35.0
LM393PWRG3	TSSOP	PW	8	2000	364.0	364.0	27.0
LM393PWRG4	TSSOP	PW	8	2000	356.0	356.0	35.0

**TUBE**

\*All dimensions are nominal

Device	Package Name	Package Type	Pins	SPQ	L (mm)	W (mm)	T (µm)	B (mm)
LM2903D	D	SOIC	8	75	506.6	8	3940	4.32
LM2903D	D	SOIC	8	75	507	8	3940	4.32
LM2903DE4	D	SOIC	8	75	507	8	3940	4.32
LM2903DE4	D	SOIC	8	75	506.6	8	3940	4.32
LM2903DG4	D	SOIC	8	75	507	8	3940	4.32
LM2903DG4	D	SOIC	8	75	506.6	8	3940	4.32
LM2903P	P	PDIP	8	50	506	13.97	11230	4.32
LM2903QD	D	SOIC	8	75	505.46	6.76	3810	4
LM2903QDG4	D	SOIC	8	75	505.46	6.76	3810	4
LM293AD	D	SOIC	8	75	506.6	8	3940	4.32
LM293AD	D	SOIC	8	75	507	8	3940	4.32
LM293ADE4	D	SOIC	8	75	507	8	3940	4.32
LM293ADE4	D	SOIC	8	75	506.6	8	3940	4.32
LM293D	D	SOIC	8	75	507	8	3940	4.32
LM293D	D	SOIC	8	75	506.6	8	3940	4.32
LM293P	P	PDIP	8	50	506.1	9	600	5.4
LM293P	P	PDIP	8	50	506	13.97	11230	4.32
LM293PE4	P	PDIP	8	50	506.1	9	600	5.4
LM293PE4	P	PDIP	8	50	506	13.97	11230	4.32
LM393AD	D	SOIC	8	75	506.6	8	3940	4.32
LM393AD	D	SOIC	8	75	507	8	3940	4.32
LM393ADE4	D	SOIC	8	75	507	8	3940	4.32
LM393ADE4	D	SOIC	8	75	506.6	8	3940	4.32
LM393ADG4	D	SOIC	8	75	507	8	3940	4.32
LM393ADG4	D	SOIC	8	75	506.6	8	3940	4.32
LM393AP	P	PDIP	8	50	506.1	9	600	5.4
LM393AP	P	PDIP	8	50	506	13.97	11230	4.32
LM393APE4	P	PDIP	8	50	506	13.97	11230	4.32
LM393APE4	P	PDIP	8	50	506.1	9	600	5.4

Device	Package Name	Package Type	Pins	SPQ	L (mm)	W (mm)	T (µm)	B (mm)
LM393D	D	SOIC	8	75	506.6	8	3940	4.32
LM393D	D	SOIC	8	75	507	8	3940	4.32
LM393DE4	D	SOIC	8	75	507	8	3940	4.32
LM393DE4	D	SOIC	8	75	506.6	8	3940	4.32
LM393DG4	D	SOIC	8	75	507	8	3940	4.32
LM393DG4	D	SOIC	8	75	506.6	8	3940	4.32
LM393P	P	PDIP	8	50	506	13.97	11230	4.32
LM393P	P	PDIP	8	50	506.1	9	600	5.4
LM393PE3	P	PDIP	8	50	506.1	9	600	5.4
LM393PE4	P	PDIP	8	50	506	13.97	11230	4.32
LM393PW	PW	TSSOP	8	150	530	10.2	3600	3.5
LM393PWG4	PW	TSSOP	8	150	530	10.2	3600	3.5



D0008A

# PACKAGE OUTLINE

SOIC - 1.75 mm max height

SMALL OUTLINE INTEGRATED CIRCUIT



4214825/C 02/2019

### NOTES:

1. Linear dimensions are in inches [millimeters]. Dimensions in parenthesis are for reference only. Controlling dimensions are in inches. Dimensioning and tolerancing per ASME Y14.5M.
2. This drawing is subject to change without notice.
3. This dimension does not include mold flash, protrusions, or gate burrs. Mold flash, protrusions, or gate burrs shall not exceed  $.006$  [0.15] per side.
4. This dimension does not include interlead flash.
5. Reference JEDEC registration MS-012, variation AA.

# EXAMPLE BOARD LAYOUT

D0008A

SOIC - 1.75 mm max height

SMALL OUTLINE INTEGRATED CIRCUIT



LAND PATTERN EXAMPLE  
 EXPOSED METAL SHOWN  
 SCALE:8X



SOLDER MASK DETAILS

4214825/C 02/2019

NOTES: (continued)

- 6. Publication IPC-7351 may have alternate designs.
- 7. Solder mask tolerances between and around signal pads can vary based on board fabrication site.

# EXAMPLE STENCIL DESIGN

D0008A

SOIC - 1.75 mm max height

SMALL OUTLINE INTEGRATED CIRCUIT



SOLDER PASTE EXAMPLE  
BASED ON .005 INCH [0.125 MM] THICK STENCIL  
SCALE:8X

4214825/C 02/2019

NOTES: (continued)

8. Laser cutting apertures with trapezoidal walls and rounded corners may offer better paste release. IPC-7525 may have alternate design recommendations.
9. Board assembly site may have different recommendations for stencil design.



# MECHANICAL DATA

PS (R-PDSO-G8)

PLASTIC SMALL-OUTLINE PACKAGE



- NOTES:
- A. All linear dimensions are in millimeters.
  - B. This drawing is subject to change without notice.
  - C. Body dimensions do not include mold flash or protrusion, not to exceed 0,15.

PS (R-PDSO-G8)

PLASTIC SMALL OUTLINE



- NOTES:
- A. All linear dimensions are in millimeters.
  - B. This drawing is subject to change without notice.
  - C. Publication IPC-7351 is recommended for alternate designs.
  - D. Laser cutting apertures with trapezoidal walls and also rounding corners will offer better paste release. Customers should contact their board assembly site for stencil design recommendations. Refer to IPC-7525 for other stencil recommendations.
  - E. Customers should contact their board fabrication site for solder mask tolerances between and around signal pads.

P (R-PDIP-T8)

PLASTIC DUAL-IN-LINE PACKAGE



- NOTES:
- A. All linear dimensions are in inches (millimeters).
  - B. This drawing is subject to change without notice.
  - C. Falls within JEDEC MS-001 variation BA.

DGK (S-PDSO-G8)

PLASTIC SMALL-OUTLINE PACKAGE



4073329/E 05/06

- NOTES:
- A. All linear dimensions are in millimeters.
  - B. This drawing is subject to change without notice.
  - C. Body length does not include mold flash, protrusions, or gate burrs. Mold flash, protrusions, or gate burrs shall not exceed 0.15 per end.
  - D. Body width does not include interlead flash. Interlead flash shall not exceed 0.50 per side.
  - E. Falls within JEDEC MO-187 variation AA, except interlead flash.



- NOTES:
- A. All linear dimensions are in millimeters.
  - B. This drawing is subject to change without notice.
  - C. Publication IPC-7351 is recommended for alternate designs.
  - D. Laser cutting apertures with trapezoidal walls and also rounding corners will offer better paste release. Customers should contact their board assembly site for stencil design recommendations. Refer to IPC-7525 for other stencil recommendations.
  - E. Customers should contact their board fabrication site for solder mask tolerances between and around signal pads.

## GENERIC PACKAGE VIEW

**DSG 8**

**WSON - 0.8 mm max height**

2 x 2, 0.5 mm pitch

PLASTIC SMALL OUTLINE - NO LEAD

This image is a representation of the package family, actual package may vary.  
Refer to the product data sheet for package details.



4224783/A

# DSG0008A

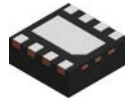

# PACKAGE OUTLINE

## WSON - 0.8 mm max height

PLASTIC SMALL OUTLINE - NO LEAD

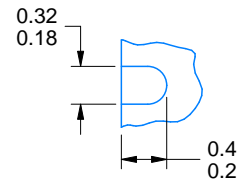

ALTERNATIVE TERMINAL SHAPE TYPICAL

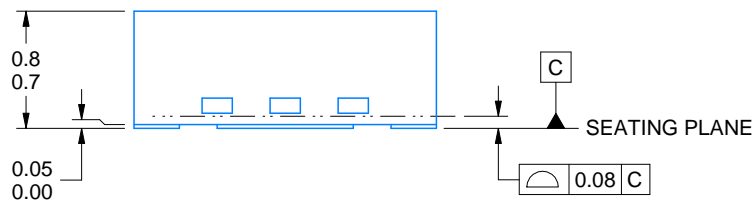

SIDE WALL METAL THICKNESS DIM A	
OPTION 1	OPTION 2
0.1	0.2



4218900/E 08/2022

### NOTES:

1. All linear dimensions are in millimeters. Any dimensions in parenthesis are for reference only. Dimensioning and tolerancing per ASME Y14.5M.
2. This drawing is subject to change without notice.
3. The package thermal pad must be soldered to the printed circuit board for thermal and mechanical performance.

# EXAMPLE BOARD LAYOUT

DSG0008A

WSON - 0.8 mm max height

PLASTIC SMALL OUTLINE - NO LEAD

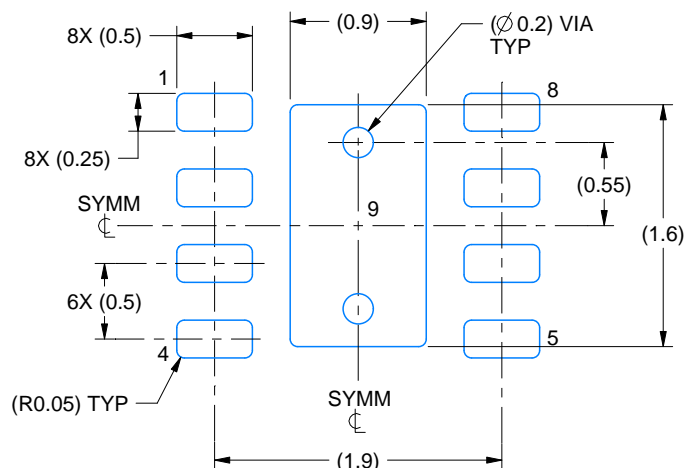

LAND PATTERN EXAMPLE  
SCALE:20X

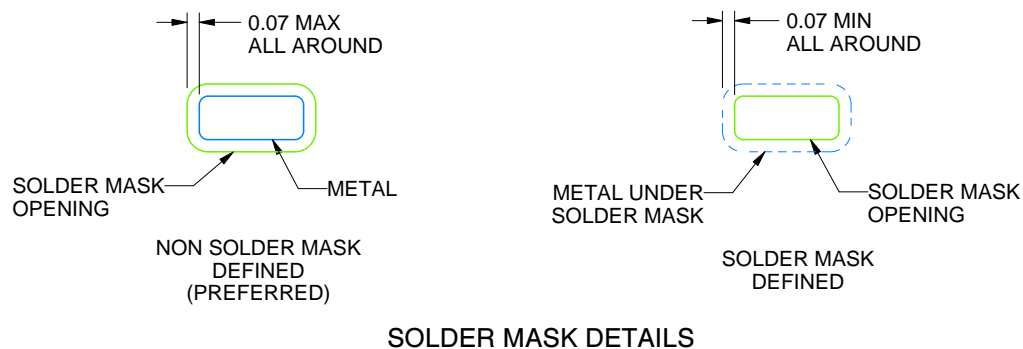

SOLDER MASK DETAILS

4218900/E 08/2022

NOTES: (continued)

4. This package is designed to be soldered to a thermal pad on the board. For more information, see Texas Instruments literature number SLUA271 ([www.ti.com/lit/sluea271](http://www.ti.com/lit/sluea271)).
5. Vias are optional depending on application, refer to device data sheet. If any vias are implemented, refer to their locations shown on this view. It is recommended that vias under paste be filled, plugged or tented.



# EXAMPLE STENCIL DESIGN

DSG0008A

WSON - 0.8 mm max height

PLASTIC SMALL OUTLINE - NO LEAD



SOLDER PASTE EXAMPLE  
BASED ON 0.125 mm THICK STENCIL

EXPOSED PAD 9:  
87% PRINTED SOLDER COVERAGE BY AREA UNDER PACKAGE  
SCALE:25X

4218900/E 08/2022

NOTES: (continued)

6. Laser cutting apertures with trapezoidal walls and rounded corners may offer better paste release. IPC-7525 may have alternate design recommendations.

PW0008A



**PACKAGE OUTLINE**  
**TSSOP - 1.2 mm max height**

SMALL OUTLINE PACKAGE



4221848/A 02/2015

NOTES:

1. All linear dimensions are in millimeters. Any dimensions in parenthesis are for reference only. Dimensioning and tolerancing per ASME Y14.5M.
2. This drawing is subject to change without notice.
3. This dimension does not include mold flash, protrusions, or gate burrs. Mold flash, protrusions, or gate burrs shall not exceed 0.15 mm per side.
4. This dimension does not include interlead flash. Interlead flash shall not exceed 0.25 mm per side.
5. Reference JEDEC registration MO-153, variation AA.

# EXAMPLE BOARD LAYOUT

PW0008A

TSSOP - 1.2 mm max height

SMALL OUTLINE PACKAGE



LAND PATTERN EXAMPLE  
SCALE:10X



SOLDER MASK DETAILS  
NOT TO SCALE

4221848/A 02/2015

NOTES: (continued)

- 6. Publication IPC-7351 may have alternate designs.
- 7. Solder mask tolerances between and around signal pads can vary based on board fabrication site.

# EXAMPLE STENCIL DESIGN

PW0008A

TSSOP - 1.2 mm max height

SMALL OUTLINE PACKAGE



SOLDER PASTE EXAMPLE  
BASED ON 0.125 mm THICK STENCIL  
SCALE:10X

4221848/A 02/2015

NOTES: (continued)

8. Laser cutting apertures with trapezoidal walls and rounded corners may offer better paste release. IPC-7525 may have alternate design recommendations.
9. Board assembly site may have different recommendations for stencil design.

# DDF0008A

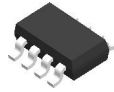

# PACKAGE OUTLINE

## SOT-23 - 1.1 mm max height

PLASTIC SMALL OUTLINE

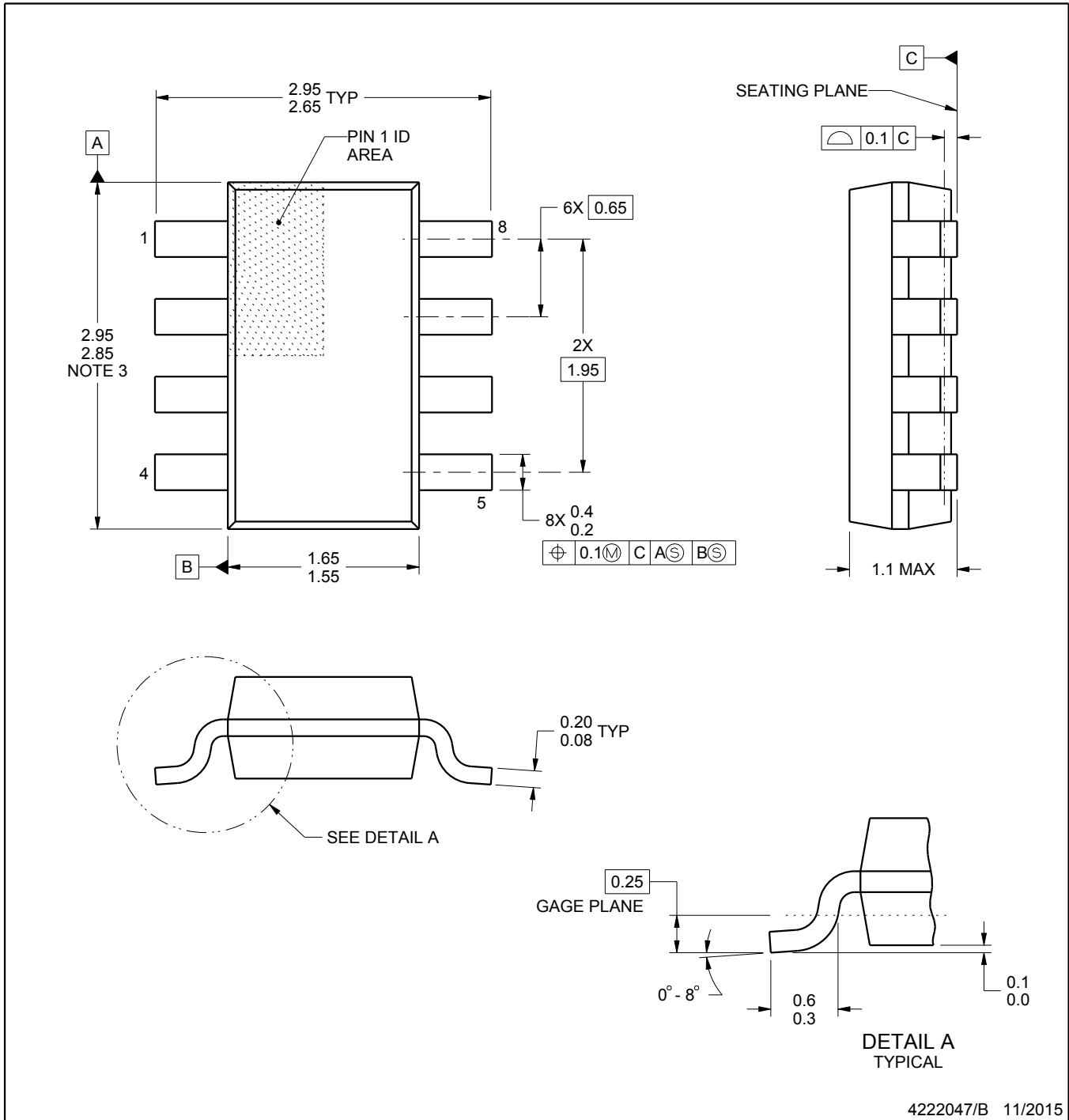

**NOTES:**

1. All linear dimensions are in millimeters. Any dimensions in parenthesis are for reference only. Dimensioning and tolerancing per ASME Y14.5M.
2. This drawing is subject to change without notice.
3. This dimension does not include mold flash, protrusions, or gate burrs. Mold flash, protrusions, or gate burrs shall not exceed 0.15 mm per side.

# EXAMPLE BOARD LAYOUT

DDF0008A

SOT-23 - 1.1 mm max height

PLASTIC SMALL OUTLINE

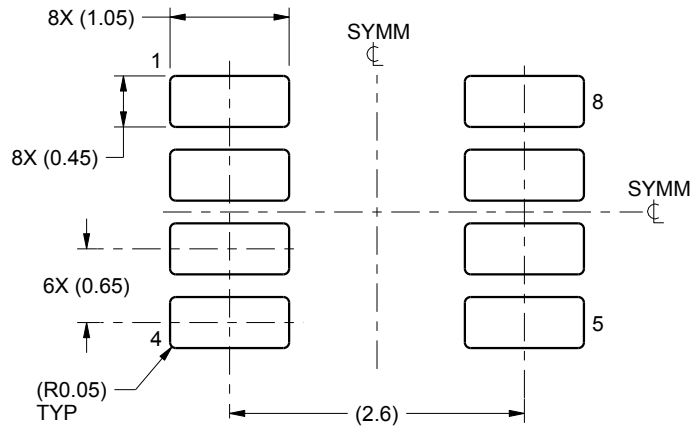

LAND PATTERN EXAMPLE  
SCALE:15X

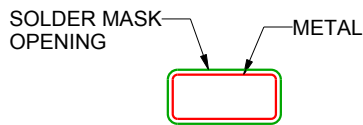

NON SOLDER MASK  
DEFINED

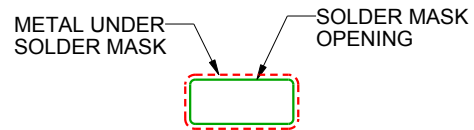

SOLDER MASK  
DEFINED

## SOLDER MASK DETAILS

4222047/B 11/2015

NOTES: (continued)

4. Publication IPC-7351 may have alternate designs.
5. Solder mask tolerances between and around signal pads can vary based on board fabrication site.

# EXAMPLE STENCIL DESIGN

DDF0008A

SOT-23 - 1.1 mm max height

PLASTIC SMALL OUTLINE

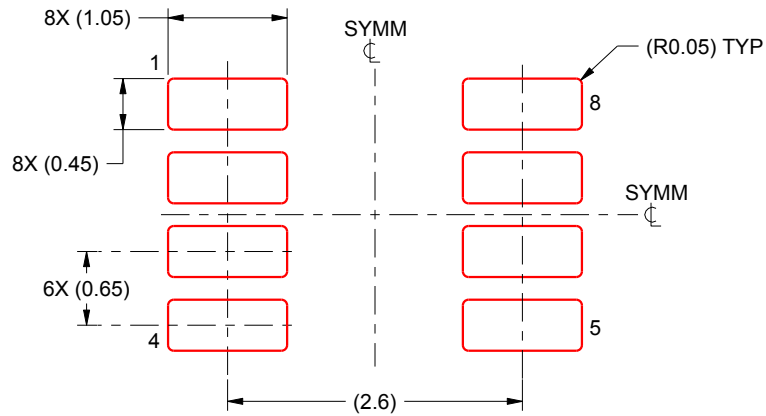

SOLDER PASTE EXAMPLE  
BASED ON 0.125 mm THICK STENCIL  
SCALE:15X

4222047/B 11/2015

NOTES: (continued)

6. Laser cutting apertures with trapezoidal walls and rounded corners may offer better paste release. IPC-7525 may have alternate design recommendations.
7. Board assembly site may have different recommendations for stencil design.

## IMPORTANT NOTICE AND DISCLAIMER

TI PROVIDES TECHNICAL AND RELIABILITY DATA (INCLUDING DATA SHEETS), DESIGN RESOURCES (INCLUDING REFERENCE DESIGNS), APPLICATION OR OTHER DESIGN ADVICE, WEB TOOLS, SAFETY INFORMATION, AND OTHER RESOURCES "AS IS" AND WITH ALL FAULTS, AND DISCLAIMS ALL WARRANTIES, EXPRESS AND IMPLIED, INCLUDING WITHOUT LIMITATION ANY IMPLIED WARRANTIES OF MERCHANTABILITY, FITNESS FOR A PARTICULAR PURPOSE OR NON-INFRINGEMENT OF THIRD PARTY INTELLECTUAL PROPERTY RIGHTS.

These resources are intended for skilled developers designing with TI products. You are solely responsible for (1) selecting the appropriate TI products for your application, (2) designing, validating and testing your application, and (3) ensuring your application meets applicable standards, and any other safety, security, regulatory or other requirements.

These resources are subject to change without notice. TI grants you permission to use these resources only for development of an application that uses the TI products described in the resource. Other reproduction and display of these resources is prohibited. No license is granted to any other TI intellectual property right or to any third party intellectual property right. TI disclaims responsibility for, and you will fully indemnify TI and its representatives against, any claims, damages, costs, losses, and liabilities arising out of your use of these resources.

TI's products are provided subject to [TI's Terms of Sale](#) or other applicable terms available either on [ti.com](http://ti.com) or provided in conjunction with such TI products. TI's provision of these resources does not expand or otherwise alter TI's applicable warranties or warranty disclaimers for TI products.

TI objects to and rejects any additional or different terms you may have proposed.

Mailing Address: Texas Instruments, Post Office Box 655303, Dallas, Texas 75265  
Copyright © 2022, Texas Instruments Incorporated